

CHAPTER 1

DNA: The Hereditary Molecule

CHAPTER 1

DNA: The Hereditary Molecule

CHAPTER 1 OVERVIEW	T4
SECTION A	
What is DNA?	S5 T5
Section A Background	T6
1. An Introduction to DNA	S6 T7
2. DNA in the News	S8 T8
SECTION B	
What Does DNA Look Like?	S9 T11
Section B Background	T12
1. Spooling Purified DNA	S10 T13
2. Extracting DNA from Calf Thymus	S13 T15
SECTION C	
What is the Structure of DNA?	S17 T19
Section C Background	T20
1. The Puzzle of DNA Structure and Replication	S18 T23
2. “The Spiral Staircase” from <i>The Cartoon Guide to Genetics</i> ...	S21 T29
3. What is a Model? And What is it Good For?	S26 T29
4. Building a Three-Dimensional DNA Model	S27 T30
5. DNA Model Questions	S31 T32
6. DNA Word Search	S32 T34
SECTION D	
What Does DNA Do?	S33 T35
Section D Background	T36
1. DNA Codes For Proteins	S34 T37
2. “How DNA Codes for Proteins” from <i>The Cartoon Guide to Genetics</i>	S37 T37
3. The Gene Expression Dance	S48 T39
4. Paper Proteins: Models for Simulating Gene Expression	S49 T69
5. Using the Genetic Code to Translate an mRNA	S51 T74
SECTION E	
How Does DNA Determine a Trait?	S53 T77
Section E Background	T78
1. An Introduction to the Connection Between Genes and Visible Traits	S54 T80
2. Shine On!	T81
a. How to Read a Micropipettor	S55 T84
b. Practicing Microbiological Techniques	S58 T87
c. Engineering Glow-in-the-Dark Bacteria	S60 T92

Chapter 1 Overview

THIS OPENING CHAPTER of Modern Genetics for all Students provides you with an exciting opportunity to capture the interest of your students in what is undeniably one of the most active and important aspects of modern biology: the study of our genes and the ways they influence our lives from conception to death.

We will begin, not with stories of a monk pattering around with peas in his garden 150 years ago (important as that story about Gregor Mendel is in the history of biology). Rather we will begin by giving the students an opportunity to view the substance that lies at the very heart of biology: DNA. Before the first class session for the genetics section of the course is over, your students will see with their own eyes that DNA is not just a theoretical abstraction, but a real, stringlike physical substance that one can actually wind up on a wooden stick- and thereby prepare for more detailed study!

After helping you to capture their attention in this way, the chapter will help you move them to progressively deeper levels of understanding of DNA structure and function with a series of puzzle-solving, model-building, and simulation exercises. But then the high point of the chapter will come at the end, when your students will become genetic engineers and will use a piece of DNA to transform dull and ordinary bacteria into ones that glow in the dark! Even more than the first exercise, the last one in this chapter should convince your students that DNA is not just some sort of textbook abstraction that they should study in order to pass future exams, but a vitally important substance that they owe it to themselves to learn more about.



CHAPTER 1

**DNA: The
Hereditary
Molecule**

SECTION A

What is DNA?

Chapter 1: Section A Background

LET'S GO! LET'S INTRODUCE your students to the exciting world of modern genetics and get them motivated to learn more about it!

In Section A.1, a short and simple reading assignment will be used to introduce your students to very basic concepts regarding the role of DNA as the carrier of the hereditary information that explains both the similarities and differences among human beings. In Section A.2, your class will be challenged to begin collecting newspaper and magazine articles about genetic research and controversies; this collection should reinforce the concept that DNA is extremely relevant to their everyday lives.



An Introduction to DNA

STUDENT PAGES 6-7

LESSON OVERVIEW

This lesson is a student reading assignment designed to familiarize your students with the general concepts underlying the study of DNA.

TIMELINE

It will take an average student 15 to 20 minutes to read this material. It could be assigned as homework.

DNA in the News

STUDENT PAGE 8

LESSON OVERVIEW

NO FIELD OF SCIENCE seems to get more press coverage these days than genetics, and certainly no molecule is mentioned in the news more than DNA is. DNA evidence makes the news with great regularity. It has been introduced as evidence in highly publicized murder trials and is now regularly being used to reexamine the guilt or innocence of prisoners convicted of violent crimes many years ago. It is being used often to determine the identity or the paternity of individuals who have been dead for a long time, and even is being used to determine the nature of obscure fossilized plants or animals. Leading medical journals regularly call press conferences to make what some have begun to call their 'gene of the month' announcements: reports of newly identified genetic defects that are thought to be responsible for breast cancer, mental illness, or some other serious human condition. Certain other press reports express either optimism or pessimism about the prospects for curing genetic ailments with gene therapy, and others deal with the controversies that surround the development of new kinds of genetically engineered plants or animals, the labeling of genetically modified (GM) foods, and efforts to patent certain human genes.

What better way to get your students to appreciate how much relevance the study of DNA has for their own lives than by getting them involved in collecting and discussing such news articles?

Your students will benefit most if they start collecting such news stories right away. Even though they will not have a deep understanding of the basic principles of heredity or of DNA structure and function, many of the articles they collect now will prove useful to them later on, when they begin dealing with various aspects of human disease (Chapter 3) and the ethical considerations related to DNA research (Chapter 4). It will undoubtedly help your students to understand the kinds of articles they should look for if you have a couple of interesting news clippings to read and discuss with them when you begin the study of genetics. Then you can challenge them to get started searching for "DNA in the News".

In order to sustain interest in this information-gathering project it will be important not to ignore the articles that the students bring to class. However, you'll probably want to avoid devoting too much time to the articles when they first appear, particularly on days for which you have a full period of activities scheduled. The following are some of the approaches that other teachers have found useful:

- require students to turn in a very brief summary of each article that they have collected, following either the guidelines given in the student pages or others that you provide;
- create a bulletin board on which students can post their articles after calling them to the attention of the class with a simple one-sentence description;

- set aside a short period each week for a discussion of the most interesting article(s) on the bulletin board- if there are more articles on the bulletin board than can be discussed in the time available, you may want to have the class vote to determine which article to discuss;
- create a scrapbook in which the students may file their articles after they have been on the bulletin board for some period of time — future students may find it instructive to compare scrapbooks compiled different years to determine how much the hot topics in genetics change from year to year.

Suggestions for various alternative ways that students might use these articles to produce a capstone experience for their study of genetics will be made in Chapter 4.

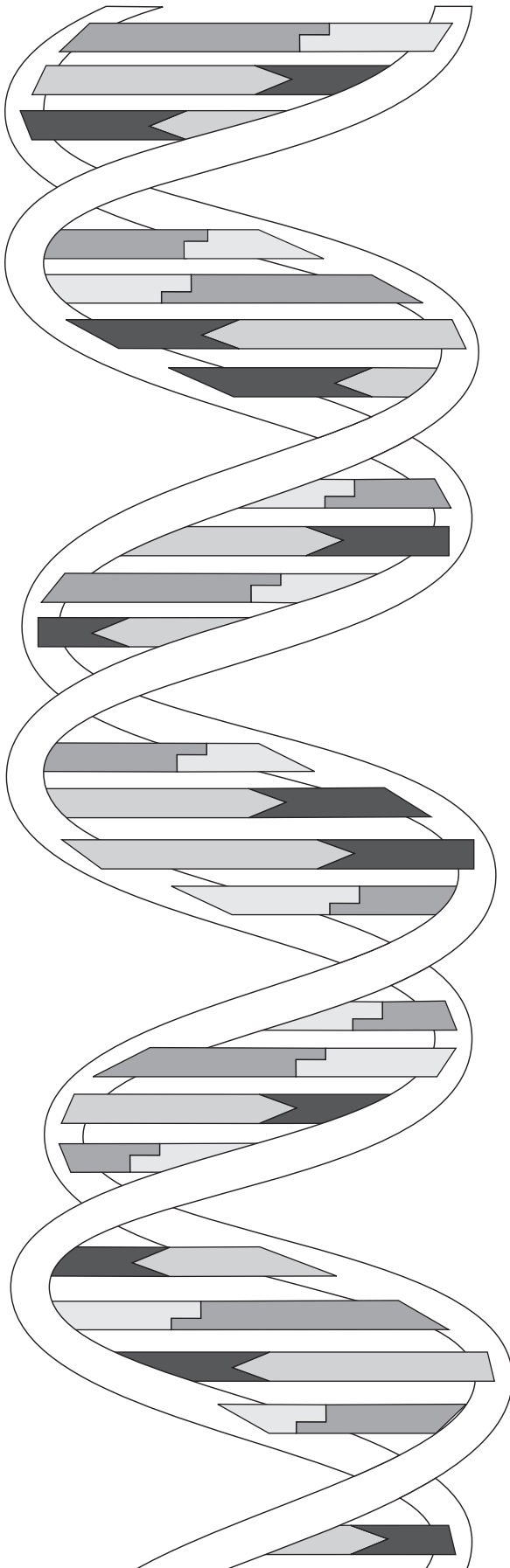

CHAPTER 1

**DNA: The
Hereditary
Molecule**

SECTION B

**What Does
DNA Look
Like?**

Chapter 1: Section B Background

THE DNA MOLECULES THAT carry heritable information from one generation of organisms to the next are surprisingly long and slender. For example, each human chromosome contains a single DNA molecule that is one to two inches long, but you would have to pack about 300,000 of these DNA molecules side by side to make a bundle as thick as a human hair. Obviously, therefore, it's impossible to see a single DNA molecule with the naked eye. Under certain conditions, however, DNA molecules will stick to one another; they will line up side-by-side and end-to-end, so that they can be wound up on a stick, forming a thick, highly visible string. In the pair of exercises included in this section, your students will take advantage of this property of DNA molecules in order to see the carrier of hereditary information with their own eyes.

In the first exercise included in this section, your students will spool DNA that has already been isolated and purified for them. In the second exercise, however, they will purify and spool DNA from a piece of calf thymus tissue that you suspend in water.

FREQUENTLY ASKED QUESTIONS

Many teachers have asked similar questions with respect to this pair of exercises:

Q: If I put some of the DNA that my students have wound up on a stick under a good light microscope, will we be able to see more details of DNA structure?

A: No, unfortunately not. Individual DNA molecules are not only too small to be seen with any light microscope, they are too small to be seen with an electron microscope (unless they have been coated with a substance that makes them much thicker). The fibers of DNA that your students wind up on a stick in these exercises will each contain millions upon millions of DNA molecules that are twisted and tangled together, and under a light microscope, you would probably be unable to distinguish a bit of this DNA from a glob of mayonnaise, or a drop of Elmer's Glue-All™.

Q: I have an agarose-gel electrophoresis apparatus in my classroom. Can I use the DNA my students spool up in this exercise to demonstrate the process of DNA electrophoresis that biologists use to separate different kinds of DNA molecules from one another?

A: No, unfortunately not. The DNA molecules in vertebrate chromosomes have molecular weights greater than a trillion. By the time chromosomal DNA has been purified, redissolved, pipetted, precipitated and then spooled up by your students, each molecule will typically have been broken in thousands of different random locations. Nevertheless, the average fragment of DNA present in such a sample will probably still have a molecular weight in the range of 10-100 million, which is still too large to be separated by conventional gel electrophoresis. Meaningful gel-electrophoretic studies of chromosomal DNA become possible only after the DNA has been digested with restriction enzymes. Because they cut DNA at predictable sites within the DNA sequence, restriction enzymes produce a set of fragments of reproducible size that are within the size range that can be separated by gel electrophoresis.



Spooling Purified DNA

STUDENT PAGES 10-11

LESSON OVERVIEW

IN THIS EXERCISE YOUR students will take advantage of the fact that DNA molecules can be made to wind around a stick. This allows them to observe the carrier of hereditary information with their own eyes.

In principle, it would be possible to get DNA from any organism for use in this exercise, since all organisms depend on DNA for their hereditary instructions. In practice, however, it has been found that one of the very best sources for obtaining large quantities of easily purified DNA is salmon sperm. There are two reasons for this. The first is that sperm cells from any type of animal have an exceptionally high nuclear-to-cytoplasmic ratio and therefore contain an unusually high ratio of DNA to other cellular materials. The second reason is that any male salmon caught while swimming upriver during the spawning season will contain a prodigious volume of sperm. Therefore, commercially available DNA Spooling Kits generally contain DNA purified from salmon sperm.

TIMELINE

This activity and discussion require about 10 minutes.

MATERIALS

For each student or pair of students:

- 1 tube containing 0.5 ml of DNA solution
- 1 tube containing 1.0 ml of alcohol
- 1 wooden or glass stirring rod

ADVANCE PREPARATION

You can purchase a kit from:

Sigma Chemical Company

PO Box 14508

St. Louis, MO 63178-9916

(800) 325-3010

www.sigma-aldrich.com

DNA Spooling Kit - Sigma Product D-8666

Follow the instructions with the kit to prepare for the activity. Each kit contains enough DNA solution for 50 samples.

OBSERVATIONS STUDENT PAGE 12

1. Describe the appearance of the liquids in the two tubes.
Descriptions will vary.
2. Can you tell which of the tubes contains DNA? How?
Answers will vary, but some students may say they think the DNA is in the tube with thicker (or cloudier, or more viscous) liquid or is in the tube that has a smaller volume of liquid.
3. Describe what happened when you first twirled the stick in or near the DNA-alcohol interface.
It began to get a little cloudy near the interface as soon as the two liquids began to mix.
4. When you lifted the stick out of the tube and a fiber of DNA followed, did you think that this was a single molecule of DNA? Why?
No, because the manual said that a single DNA molecule is much too small to see with the naked eye. (Experience indicates, however, that many students will say "yes" followed by some incorrect explanation; they should be guided toward the correct answer.)
5. How would you describe the appearance of DNA to someone who had never seen it?
It's kind of goopy and stringy.
6. What do you think it is about the biology of salmon and sperm cells that makes it easy to isolate a large quantity of DNA from salmon sperm?
Answers to this will vary widely, but you should guide students toward recognition of the facts that (a) all sperm contain a nucleus, but very little cytoplasm compared to other cells, and thus have a high ratio of DNA to other cellular constituents and (b) during spawning season, male salmon need huge quantities of sperm to fertilize the eggs a female deposits at the bottom of a fast-flowing river, and thus a single male salmon can provide lots of sperm from which DNA can be extracted.



Extracting DNA from Calf Thymus

STUDENT PAGES 13-14

LESSON OVERVIEW

In the previous exercise, your students spooled DNA that had already been purified for them from salmon sperm by someone else. But in the real world of DNA analysis (in a crime lab, for example), getting a sample of DNA to study is never quite that simple. If a technician in a crime lab is asked to isolate DNA from a sample that was found at a crime scene (such as a few hairs, or a piece of skin), there are always several similar steps that need to be taken to get ready for isolating the DNA. First, the tissue sample from which DNA is to be extracted must be broken up into tiny fragments and suspended in water. Next, the lipids present in the various cellular membranes must be dissolved with a detergent, so that the DNA will be forced to dissolve in the water. Then the many proteins present in the tissue (which are always much more abundant than the DNA) must be removed or destroyed, because if they were not, they would precipitate when the alcohol was added and would make a gooey mess from which the DNA could never be isolated. Only after the sample has been pretreated in these three ways would the technician be able to spool out the DNA for further analysis.

In this exercise, you and your students will imitate such a technician by isolating DNA from a tissue sample. First, you will use a blender to break up a piece of thymus in water so that you will be able to distribute samples of ‘thymus soup’ to your students. Next, they will treat the thymus soup with detergent to dissolve all of the membrane lipids (Woolite™ works well for this). Then they will add the protein-digesting enzyme papain (which is derived from papaya fruit and which is the active ingredient in Adolph’s Meat Tenderizer™) to break down all of the proteins. Finally, they will add alcohol and spool out the purified DNA.

The thymus (sometimes called “throat sweetbread” by butchers) is an organ found in the neck of every mammal and serves as a source of cells for the immune system. Thymus is often used as the starting material for DNA isolation because, like salmon sperm, thymus cells contain large nuclei but very little cytoplasm. Thus, they have a higher ratio of DNA to proteins and other substances than most cells of the body do. In addition, of course, your local butcher will find it easier to get you some thymus than some salmon sperm! But because DNA is present in all cells, in principle, other cellular materials could be used as a source of DNA for this exercise. You might wish to try using bananas or bacteria for this purpose sometime.

TIMELINE

This laboratory exercise requires about 30 minutes.

MATERIALS

Note: we recommend that you allow students to perform this exercise individually, rather than in groups, in order to provide each of them a real hands-on experience. If you do so, however, you will be well advised to provide multiple containers of the reagents and dispensing devices at each of four dispensing stations, in order to prevent lengthy backups. The instructions below assume a class of thirty students working as individuals. If you structure the exercise differently, you can cut back on other materials accordingly; but we do not recommend trying to process a smaller volume of “thymus soup” in the blender.

Station 1:

- 1 150 ml beaker containing 100 ml of tap water
- 1 piece of calf thymus about the size of a quarter
- 1 blender/food processor
- 30 16 x 100 mm test tubes in a test tube rack

Station 2:

- 5 or 6 test tubes or small beakers containing Woolite or dishwashing detergent
- 5 or 6 dropping pipettes

Station 3:

- 5 or 6 small beakers or weigh boats containing Adolph’s Meat Tenderizer
- 5 or 6 small spatulas (see Hints and Troubleshooting)

Station 4:

- 5 or 6 50 ml beakers each containing about 40 ml of cold alcohol (95% methyl or ethyl or 50% isopropyl alcohol)
- 30 wooden sticks
- 1 roll of paper towels

ADVANCE PREPARATION

- Calf thymus can be purchased at a local meat market. It may be necessary to order it in advance, and the butcher may not understand what you want unless you call it “throat sweet breads.” It can be cut into small pieces, stored in the freezer in a plastic bag, and removed when needed. Thymus stored this way can be used for several years.
- Store the alcohol for this exercise in the refrigerator so that it will be cold at class time.
- Wooden applicator sticks for use in this exercise may be purchased from Fisher Scientific (1-800-766-7000; www.fishersci.com) Cat. No. 01-340.
- Before class starts, prepare the “thymus soup” for distribution at Station 1. Pour the water into the blender, cut the thymus into smaller pieces and drop it into the blender. Process until the thymus appears to be thoroughly dispersed in the water. Pour the processed thymus soup back into the beaker, and then pour about 3 ml into each test tube.
- Set up the other three distribution stations. Wait until the last minute to get the alcohol out of the refrigerator.

HINTS AND TROUBLESHOOTING

Small spatulas can be made by snipping the ends off of soda straws to produce small scoops. You can also make spatulas by cutting diagonally across the bulb ends of dropping pipettes.

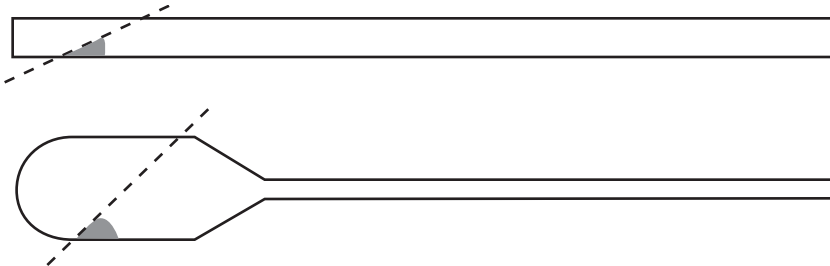

Cut soda straw or pipette as shown to create a small spatula.
Shaded area indicates amount of Adolph's Meat Tenderizer to use.

Remind the students to use VERY little of the Adolph's. Too much settles to the bottom of the tube and displaces too much liquid. The small dark triangle on the drawing of the homemade spatula represents the approximate amount of Adolph's needed.

ANSWERS TO OBSERVATIONS STUDENT PAGE 15

1. What does the "thymus soup" look like?
It is a very cloudy looking suspension.
2. How does its appearance change as you add the detergent and swirl it in?
The suspension gets a little less cloudy.
3. What do you think is happening at this step?
The lipids from the cellular membranes are dissolving.
4. Does the appearance of the mixture change as you add the meat tenderizer and swirl it in? If so, how?
We didn't notice much change.
5. What do you think is happening at this step?
The proteins are being broken down by the meat tenderizer.
6. Describe the appearance of the mixture just after you added the alcohol.
Some stringy white stuff appeared at the interface between the thymus soup and the alcohol as the tube was swirled.
7. What do you think is happening at this step?
The DNA is beginning to come out of solution.

8. What did you see as you twirled the stick at the interface?
The white strings stuck to the stick, and as the stick was twirled, more strings formed and wound up on the stick.
9. What do you think is happening at this step?
The DNA molecules are sticking to one another side by side and end-to-end and are forming a long, sticky string that gets wound up on the stick.
10. What happens as you slowly pull the stick out of the tube?
At first the string grows longer in the region of the interface as the stick is withdrawn, but eventually the string breaks.
11. What does DNA look like?
A sticky, stringy white mass of glop.

ANSWERS TO DISCUSSION AND CONCLUSION QUESTIONS STUDENT PAGE 16

1. Explain why DNA is so important to study.
It contains the coded instructions that are essential for life.
2. Describe in your own words how one isolates DNA from animal tissue.
First, you break up the tissue in water with a blender. Then you mix in detergent and meat tenderizer. Finally, you add some alcohol, and suddenly the DNA becomes visible.
3. Explain the function of the following reagents: Woolite, Adolph's Meat Tenderizer and alcohol.
The Woolite is a detergent that dissolves all the cellular membranes and frees up the chromosomes. The Adolph's Meat Tenderizer is an enzyme that breaks down proteins; it is used to remove the proteins from the chromosomes. The alcohol precipitates the DNA, separating it from most of the other substances present in the tissue.
4. What does the DNA look like at the end of the procedure?
It is a gloppy, stringy mass that sticks to the stick.

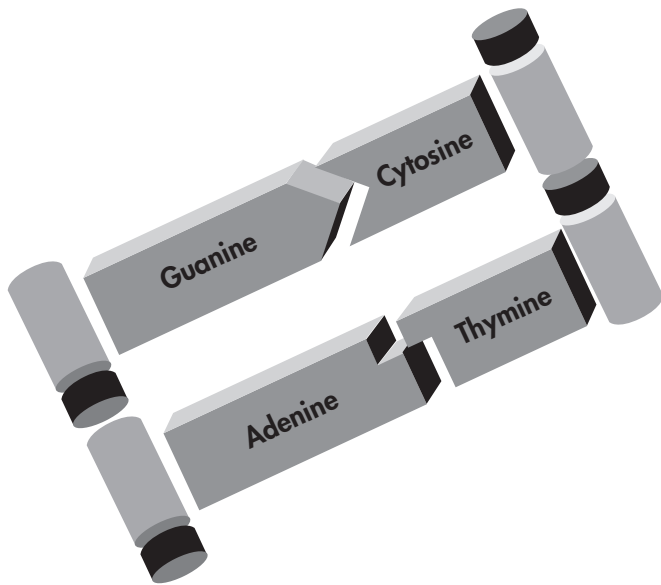

CHAPTER 1

**DNA: The
Hereditary
Molecule**

SECTION C

What is the Structure of DNA?

Chapter 1: Section C Background

THE ABILITY OF DNA to act as a reservoir of hereditary information resides in four aspects of its structure:

1. Each building block of DNA (called a **nucleotide**) contains one of four nitrogenous bases: **adenine (A)**, **cytosine (C)**, **guanine (G)**, or **thymine (T)**.
2. Each DNA molecule consists of two **strands**, in each of which these four kinds of nucleotides are connected by chemical bonds into long, linear arrays.
3. In principle, the four different kinds of nucleotides may be connected in any possible sequence within a single strand of DNA.
4. In practice, however, the sequence of nucleotides that is present in one strand of DNA specifies the sequence of nucleotides that must be present in its partner strand. This is because an A on one DNA strand is always paired with a T on the other strand, and a G on one strand is always paired with a C on the other strand. These two invariant relationships (A pairs with T and G pairs with C) are known as the **base-pairing rules**.

"But why," your students are likely ask, "is A always paired with T? And why is G always paired with C? Why can't A pair with C or G? Or why couldn't G pair with T or A?" Good questions! The answer is that the base-pairing rules are a direct consequence of the chemical structures of A, G, C, and T as well as the nature of the chemical bonds that hold the two strands of a DNA molecule together. This is explained to some extent in the excerpt from *The Cartoon Guide to Genetics* that your students will read in Section C.2, but the concepts are so fundamental that it is worthwhile to spell them out in a bit more detail here.

The DNA structure diagram on page T22 illustrates four features of DNA structure that are relevant to understanding the base-pairing rules:

1. Two of the nitrogenous bases present in DNA (G and A) contain two rings and thus are much larger than the other two (C and T), which have only one. Nitrogenous bases with two rings (such as G and A) are known as **purines**, whereas nitrogenous bases with a single ring (such as C and T) are known as **pyrimidines**.
2. A stable DNA structure is formed only when the two strands are a constant distance apart, and this only happens when a purine on one strand is paired with a pyrimidine on the other strand. The strands would have to move much further apart to permit a purine to pair with another purine and would have to move much closer together to permit a pyrimidine to pair with a pyrimidine. So G-A and C-T base pairs would not be compatible with a stable DNA structure.

3. The two strands of DNA are held together by a series of **hydrogen bonds**, which are the weak bonds formed when a single hydrogen (H) atom is positioned between (and thus "shared" by) two nitrogen (N) atoms or one nitrogen and one oxygen (O) atom. The arrangements of atoms in the four kinds of nitrogenous bases is such that two hydrogen bonds are formed automatically when A and T are present on opposite DNA strands, and three are formed when G and C come together this way.

Note also on the diagram that the locations of the atoms that participate in formation of hydrogen bonds are such that the hydrogen bonds are the same length in the G-C and the A-T base pairs. A-C or G-T pairs would not be able to form similar sets of hydrogen bonds.

4. The hydrogen bonds described above and shown in the diagram can be formed only when the two DNA strands are **antiparallel** (run in opposite directions from one another) and are coiled into a pair of helices. A stable two-stranded molecule could not be formed if the two strands ran in the same direction or were stretched out straight.

The latter features may not be obvious from looking at a two-dimensional drawing of DNA like the one shown on the next page, but they become very obvious if one tries to build a DNA model, starting with realistic three-dimensional scale models of the nucleotides. It was when Watson and Crick tried to build such a model that they discovered the double-helical nature of DNA.

In exercise C.1, your students will construct a flat model of DNA using pieces of colored paper to 'solve a puzzle.' This should get them started on the path toward understanding DNA structure, even though the puzzle (being flat) will not illustrate the helical nature of DNA. First, it will allow them to 'discover' the base pairing rules for themselves. Second, it will allow them to discover that the base-pairing rules mean that each DNA molecule contains all of the information required for constructing a second molecule of the very same sort (i.e., the information required for **DNA replication**).

In C.2, they will learn how the structure of the DNA double helix was deduced, by reading a rather charming excerpt from *The Cartoon Guide to Genetics*.

In C.3, they will read a short segment on the importance of model building in biology; and then in C.4, they will build a simple model of the DNA double helix. Having done so, they will be challenged to consider the strengths and weaknesses of the two kinds of DNA models they have now constructed.

In C.5, they will label all the parts of a drawing of a short piece of DNA. This exercise should reinforce their understanding of the differences in size between purines and pyrimidines, of the base-pairing rules, and of the fact that the two strands of a double helix run in opposite directions.

Finally in C.6, they will have the fun of using a DNA 'Word Search' to reinforce their understanding of certain terms and concepts that they should have mastered in this unit.

DNA STRUCTURE

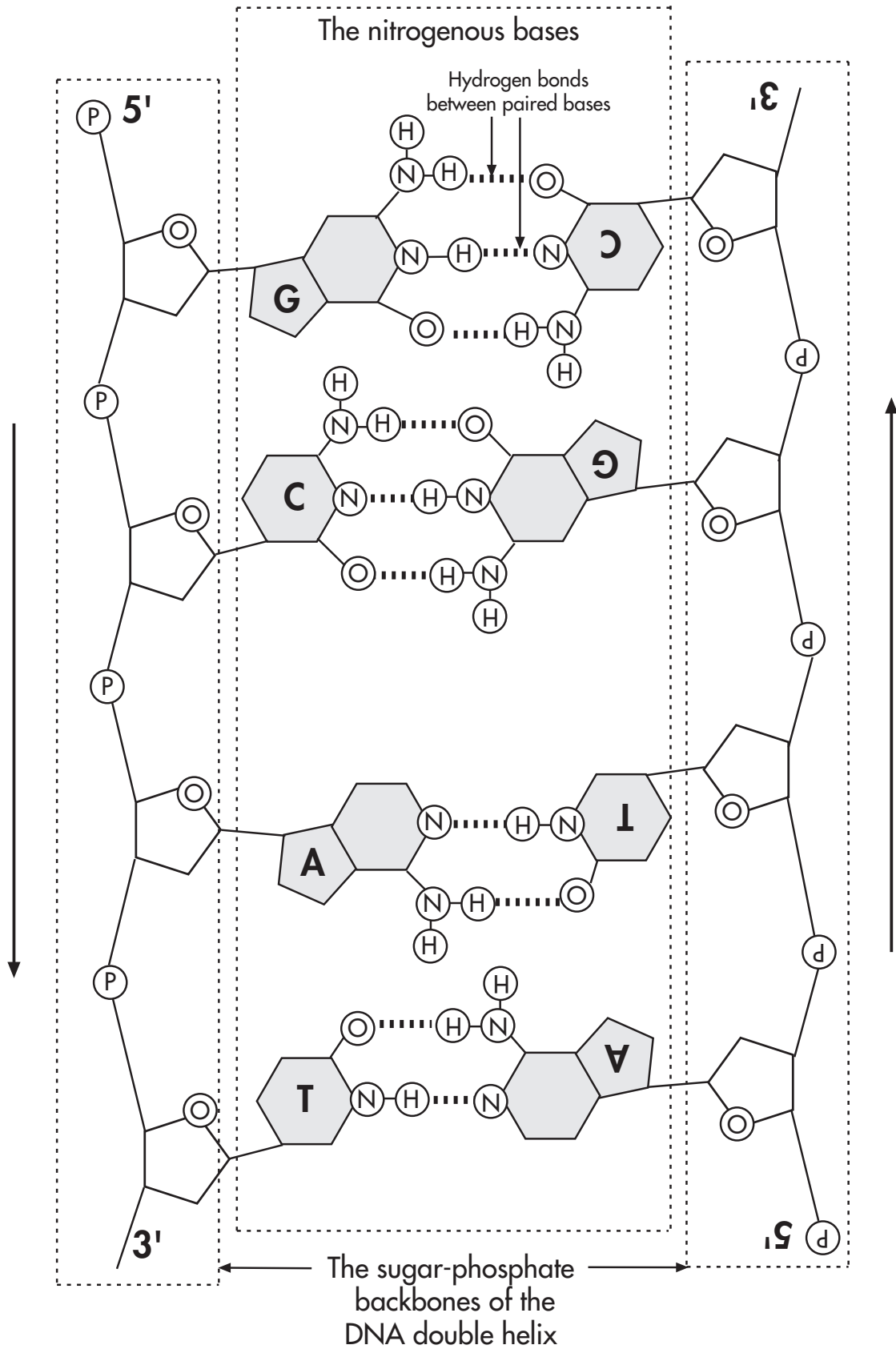



The Puzzle of DNA Structure and Replication

STUDENT PAGES 18-19

LESSON OVERVIEW

This activity provides students with the opportunity to discover for themselves the important ideas of base-pair complementarity and the role that this plays in DNA replication.

MATERIALS

For each student or pair of students:
puzzle pieces (see advance preparation below)
one half of a file folder per student

ADVANCE PREPARATION

Puzzle pieces will need to be prepared before the first class, but then they can be reused. Photocopy each of the puzzle pages on a different color of paper. Each sheet contains 20 puzzle pieces of one type. You will need 10 puzzle pieces of each type for each bag. So for a class of 20, for example, you would need 200 pieces of each type and thus would need to make ten copies of each page. The pieces will hold up much longer, of course, if you laminate them before cutting them out.

TIMELINE

Part A of this activity requires about 10 minutes. Then students answer the first four questions on base-pairing rules before going on to Part B.

Part B requires approximately 5 minutes. Students then answer Questions 5 and 6 about DNA replication.

ANSWERS TO ANALYSIS AND CONCLUSION QUESTIONS STUDENT PAGE 20

1. Do you see any consistent relationship between the DNA bases (puzzle pieces) in one strand of your puzzle and the bases with which they are paired in the other strand? If so, state the nature of the relationship(s) you see.
Yes. T is always paired with A, and C is always paired with G.
2. Half of the puzzle pieces that you were given (the A's and G's) were much larger than the other pieces (the C's and T's). Did this size difference cause your DNA model to be significantly wider in some parts than in others? If not, why not?
No. Because one of the large bases (A or G) is always paired with one of the small ones (T or C), a double-stranded DNA molecule always has a constant width.
3. Is there any consistent difference in the way that the puzzle pieces in the right-hand strands and the left-hand strands of your model are oriented? If so, what is the difference?
Yes. The two strands run in opposite directions.
4. How can you account for the fact that no matter which bases were selected for the left-hand strand of a DNA molecule, everyone had just the right pieces left over to assemble a matching right-hand strand?
We all started with equal numbers of each kind of nitrogenous base. Because G always pairs with C and T always pairs with A, you always can build a two-stranded molecule if you start with as many A's as T's and as many C's as G's.
5. Are the two DNA puzzles that you now have the same or different? How can you account for this?
They are identical. Because of the base-pairing rules, each individual strand of a two-stranded DNA molecule contains all of the information required to build a new two-stranded molecule that is just like the starting molecule.
6. What do you suppose biologists call this process of making two identical double-stranded DNA molecules from one when it occurs in cells?
They call it "DNA replication."

TEMPLATES

Puzzle piece templates follow on pages T25-T28.

G	G
G	G
G	G
G	G
G	G
G	G
G	G
G	G
G	G
G	G
G	G

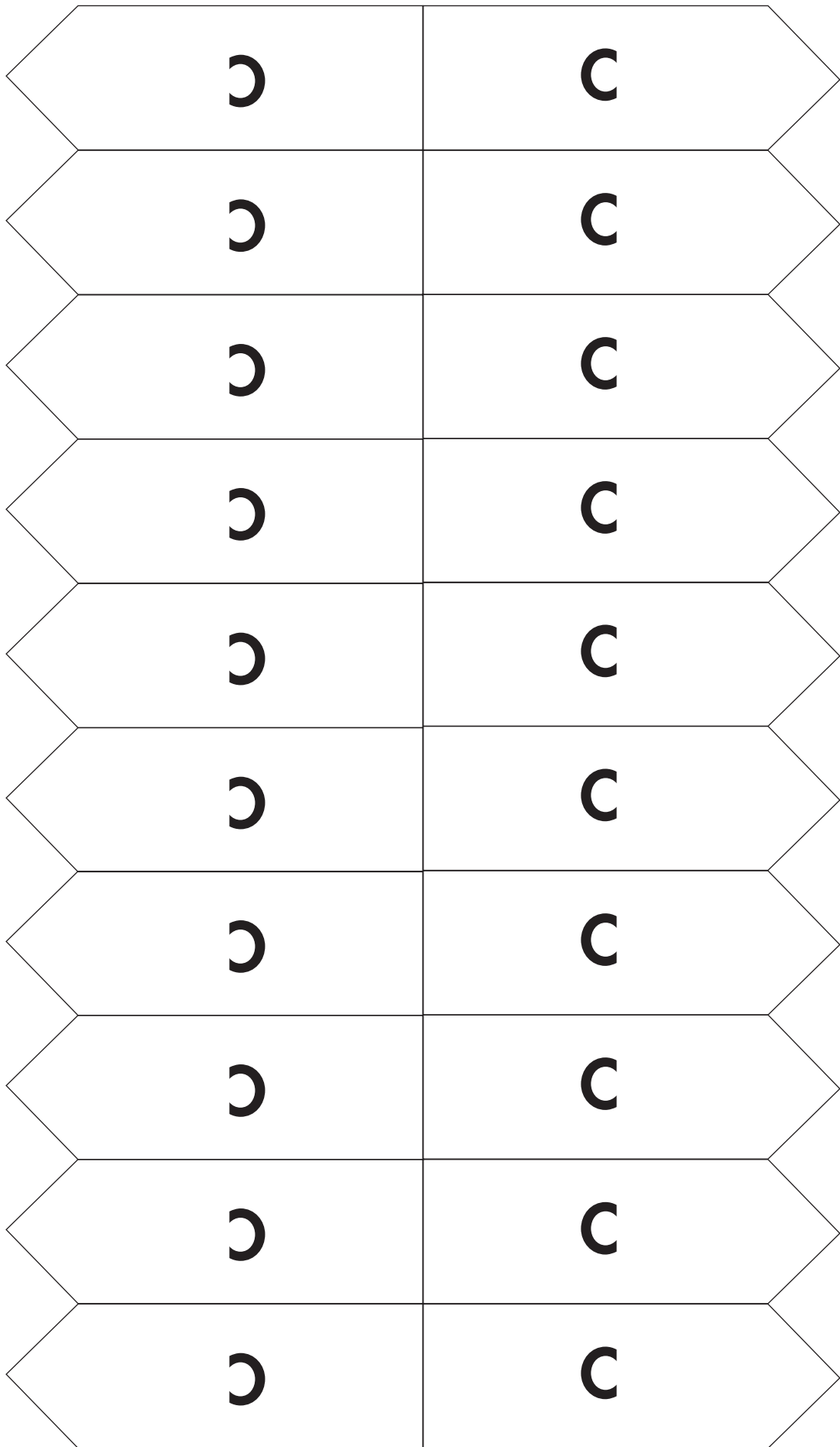

A	A
A	A
A	A
A	A
A	A
A	A
A	A
A	A
A	A
A	A
A	A

I	T
I	T
I	T
I	T
I	T
I	T
I	T
I	T
I	T
I	T
I	T



The Spiral Staircase

STUDENT PAGES 21-25

LESSON OVERVIEW

“The Spiral Staircase” is an excerpt from *The Cartoon Guide to Genetics* by Larry Gonick and Mark Wheelis, which can be ordered from Harper Collins Publisher, 10 East 53rd Street, New York, NY 10022 (ISBN 0-06-460416-0). Portions of the text are reprinted with permission of the authors. This reading is a user-friendly way to introduce students to the basics of DNA structure.

TIMELINE

This reading requires about 5-10 minutes and may be used as a homework assignment.

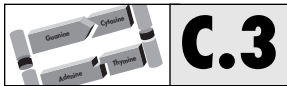

What is a Model? And What is it Good For?

STUDENT PAGE 26

LESSON OVERVIEW

This reading is to be used as an introduction to Lesson C.4 “Building a Three-Dimensional DNA Model.”

TIMELINE

This reading requires only a couple of minutes. You may want the students to read it as a homework assignment before building the three-dimensional models in class.



Building a Three-Dimensional DNA Model

STUDENT PAGES 27-29

LESSON OVERVIEW

In this lesson, the students will build a second model. This one will be made from three-dimensional plastic pieces. The students will then be asked to observe the three-dimensional model (B) and compare its qualities to the flat, paper model (A) that they made at the beginning of this section.

TIMELINE

This model-building exercise can be completed in 50 minutes if students are prepared and are on task. It is often difficult to convince students to take the model apart to be used for the next class immediately after they have constructed it. So, either prepare them for this or have another set available for the next class period.

MATERIALS

For each student or pair of students:
1 DNA Model Kit

The kits can be ordered from:
Frey Scientific
100 Paragon Parkway
P.O. Box 8101
Mansfield, OH 44901-8101
(800) 225-3739
www.freyscientific.com
DNA Model Kit- Catalog # G11406

ADVANCE PREPARATION

If your DNA Model Kits have been used before, it is a good idea to check them to be sure that no parts are missing. There is also a list of kit materials on the Student Pages so the students can do this. This would add to the time necessary for completion.

ANSWERS TO ANALYSIS AND CONCLUSIONS STUDENT PAGE 30

1. What feature or features of a double-stranded DNA molecule are represented better in model A than in model B?

In model A, we clearly see that two kinds of nitrogenous bases (A and G) are larger than the other two kinds (T and C) and that there appears to be a physical basis for the fact that A pairs only with T and G pairs only with C. In model B, the nitrogenous bases all appear to be the same size and shape, and thus there is no obvious reason why A could not pair with G- or even with another A. Also, in model A we could see more clearly that the two chains were running in opposite directions, whereas in model B the only difference between the two chains was in the position of the red phosphate groups at their ends.

2. What feature or features of a double-stranded DNA molecule are represented better in model B than in model A?

Well, of course, model B shows the three-dimensional (double-helical) shape of DNA much better than model A does. In addition, the straws and connectors used in model B represent the sugar-phosphate backbone of each chain much better than the pencil lines in model A did.

3. What feature or features of a double-stranded DNA molecule that you read about in the excerpt from the Cartoon Guide to Genetics are not well represented in either model A or model B?

Neither model shows clearly that the nitrogenous bases all lay flat and parallel to one another, like the surfaces of stairs in a spiral staircase.

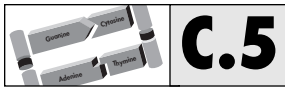

DNA Model Questions

STUDENT PAGE 31

LESSON OVERVIEW

This exercise uses a different approach to reinforce students' understanding of basic aspects of DNA structure. It emphasizes a feature that is also emphasized in your BACKGROUND information for Section C (T20) — that the two chains of a DNA molecule must run in anti-parallel (opposite) directions in order for the bases to pair properly and form the hydrogen bonds that hold the two strands together.

To reinforce this concept, suggest to the students that they should turn the page 180° before labeling the right-hand half of this double-stranded molecule. Thus, the labels should end up in the orientations shown on the next page, which shows that the two strands are identical in basic structure but are oriented in opposite directions.

TIMELINE

This exercise requires about 15 minutes.

ANSWERS TO QUESTIONS

- Label each sugar group on the diagram with a letter S.
See diagram
- Label each phosphate group with a letter P. *See diagram*
- One adenine (A) and one guanine (G) have already been labeled. Label the rest of the nitrogenous bases. *See diagram*
- Circle one nucleotide. What three things go together to make a nucleotide? *A sugar, a phosphate and a nitrogenous base*
- The sides of the DNA ladder are made up of alternating *sugar* and *phosphate* groups.
- The rungs of the DNA ladder are made up of *base pairs*.
- A is always paired with T.
- G is always paired with C.
- Paired bases are held together by weak bonds called *hydrogen* bonds.
- When the DNA ladder twists the way it normally does, the shape of the molecule is called a *double helix*.

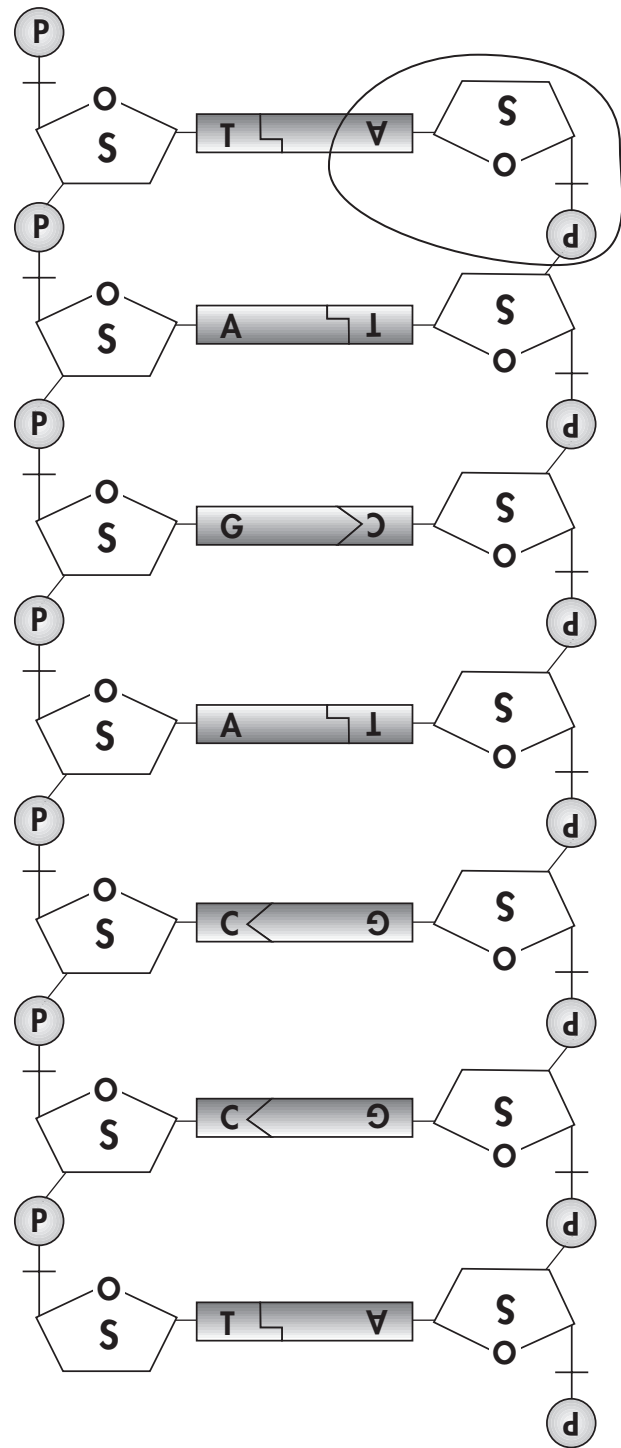

DNA Word Search

STUDENT PAGE 32

LESSON OVERVIEW

This is a fun exercise, in which students use the ever-popular word-search format to reinforce their learning of basic terminology and concepts related to DNA structure.

TIMELINE

This exercise requires about 15 minutes. It could be assigned for homework.

ANSWERS

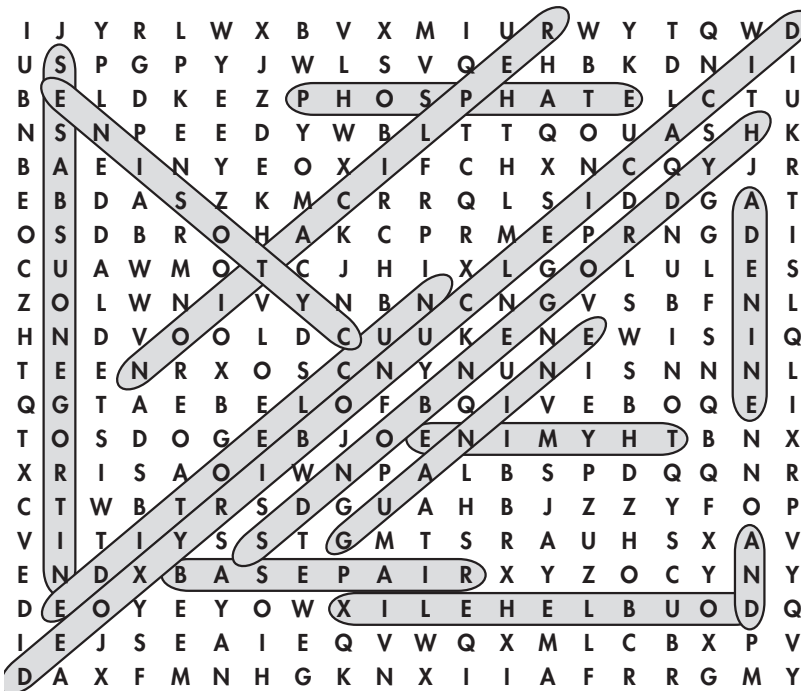

1. The nitrogenous base A adenine
2. The nitrogenous base C cytosine
3. The nitrogenous base G guanine
4. The nitrogenous base T thymine
5. The genetic material inside all cells
DNA (abbreviation)
6. The full name for DNA
deoxyribonucleic acid (two words)
7. The scientific name for the shape of the DNA molecule double helix (two words)
8. The arrangement of two bases in the DNA molecule forms a base pair (two words)
9. The name of the bonds that hold the two strands of DNA together (between the bases) hydrogen bonds (two words)
10. Pairs of these molecules form the steps or rungs in the DNA molecule (two words) nitrogenous bases
11. This subunit of DNA has three parts: a phosphate, a sugar and a nitrogenous base nucleotide
12. The long backbones of the DNA molecule are made of alternating sugar and phosphate groups
13. This process occurs when DNA makes a copy of itself replication



CHAPTER 1

**DNA: The
Hereditary
Molecule**

SECTION D

**What Does
DNA Do?**

Chapter 1: Section D Background

ALTHOUGH DNA IS THE hereditary material of all living cells and organisms, it is powerless to mediate any of the essential reactions of life or to form the structural frameworks that are used for building complex organisms out of cells. Those important jobs are fulfilled by a very different class of molecules called **proteins**. DNA’s “claim to fame” is that it is the class of molecules within which all of the instructions are stored that are necessary for making all of the proteins in the living world. However, the protein-making instructions that are present in DNA would never be of any significance if they were not interpreted and put into use by a third class of molecules, **ribonucleic acid**, or **RNA**, which (as the name suggests) is rather similar in structure to DNA.

Which of these three classes of molecules is most important in the living world? That’s like asking which is the most important leg of a three-legged stool: remove any one of the three legs and the whole thing falls down!

The process by which the information stored in a functional subunit of DNA (a gene) is used to produce one particular kind of protein is called **gene expression**. This process consists of two essential steps, **transcription** and **translation**, the relationship between which can be diagrammed as follows:



This section will introduce your students to the gene expression system with several activities. First, they will learn that the importance of DNA is that it carries coded instructions for making proteins, which are the molecules that mediate all of the reactions of life. Then they will read an excerpt from *The Cartoon Guide to Genetics* to learn how three types of RNAs interact to convert the sequence of nucleotides present in a piece of DNA (a gene) into the sequence of amino acids required to make a particular kind of protein. Then, in “The Gene Expression Dance,” they will perform a group simulation of the processes of transcription and translation, in which the nucleotide sequence of a gene is first converted to a sequence of codons in RNA and then to a sequence of amino acids in a protein. Afterwards, they will repeat this process individually with paper models. Finally, they will use a work sheet to determine the RNA and amino acid sequences that are encoded by a short stretch of DNA. In the process, they will learn how to use the table that indicates what kind of amino acid is specified by each of the 64 possible codons of an mRNA molecule. This table is known as the **genetic code**.

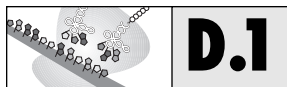

DNA Codes For Proteins

STUDENT PAGES 34-36

LESSON OVERVIEW

This overview is an introduction to what a protein is, what it does, and the relationship between DNA and protein. It also contains a chart of a few human proteins and their function.

TIMELINE

This reading requires about 5-10 minutes.

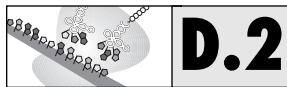

How DNA Codes For Proteins

STUDENT PAGES 37-46

LESSON OVERVIEW

“How DNA Codes for Proteins” is an excerpt from *The Cartoon Guide to Genetics* by Larry Gonick and Mark Wheelis. Portions of the text are reprinted in this curriculum unit with permission of the authors. This reading introduces the processes of transcription and translation and is followed by a set of questions to check the students’ understanding of the material.

TIMELINE

The reading and questions require about 15 minutes.

ANSWERS TO QUESTIONS STUDENT PAGE 47

1. What is the relationship between genes and proteins?
A gene carries the information required to make a particular kind of protein.
2. How does RNA differ from DNA?
The sugar in RNA is ribose, instead of deoxyribose, the base uracil (U) is present in place of thymine (T), and RNA molecules are usually single-stranded and shorter than DNA molecules.

3. What is the molecule that carries the information from a gene to the place where a protein will be made?
messenger RNA or mRNA
4. What is the process by which such a molecule is made?
transcription
5. What is the enzyme that mediates the process named above?
RNA polymerase
6. What is the structure on which proteins are made?
a ribosome
7. How many bases form one “word” of the RNA message?
three
8. What is the technical name for such a group of bases found on mRNA?
a codon
9. What is another term for protein synthesis?
translation
10. What is the group of molecules that translates the genetic code?
tRNAs
11. What is an anticodon?
the triplet of bases on a tRNA that recognizes and base pairs to one particular mRNA codon
12. At the tail end of each tRNA molecule, an *enzyme* attaches the appropriate *amino acid* molecule to the tRNA.
13. What happens when two tRNAs are side by side on a ribosome?
their amino acids become linked to one another
14. The first codon on an mRNA always is *AUG*.
15. This codes for the amino acid called *methionine*.

The Gene Expression Dance STUDENT PAGE 48

LESSON OVERVIEW

This role-playing gives students a chance to act out the processes of transcription and translation.

TIME LINE

This exercise requires 15-20 minutes.

MATERIALS

For each class:

- 1 set of gene-expression flashcards

ADVANCE PREPARATION

Flashcards for this activity need to be made by photocopying the next 28 pages before the first class. Use different colors for the DNA, the mRNA and the tRNA-amino-acid cards. If laminated, these cards may be reused many times. In order to have the “punch line” come out right, it is necessary to photocopy the tRNA cards and the “word” cards double sided, or to glue each “word” to the back of the appropriate card. The correct matches are shown in the upper right of tRNA and word cards. Note that it works best if the words are printed upside down on the back of the tRNA cards.

DIRECTIONS

You will need to “choreograph” the dance fairly carefully in order to produce the correct message at the end. We suggest that you designate one corner of the room as the nucleus and another as the ribosome.

1. Distribute the flashcards to the students and indicate who will be playing the DNA, the mRNA, and the tRNA-amino acid roles.
2. Instruct the DNA triplets to dance into the nucleus and line up so that the numbers on their cards are in order from their left to right. Once they are lined up in order, have them link arms and turn to face the class with their flash cards held so that all letters are visible. (Check that the numbers are in order, with #1 to your right as you face them.)
3. **Transcription.** Have the mRNA codons dance into the nucleus one by one to find and base pair with their DNA-triplet partners. As soon as codon #2 has base paired, it should link arms with #1, and so forth, until the mRNA has been completed.

4. Now have the mRNA molecule separate from the DNA and dance out of the nucleus and over to the ribosome. Once it has reached the ribosome, have the mRNA turn to face the class (arms linked the whole time) with flashcards held so that all letters are visible. (Codon #1 should now be on your left.) As the mRNA leaves the nucleus, the DNA students may return to their seats.
5. **Translation.** Now have the tRNA-amino-acid molecules dance up to the mRNA one by one and base pair their anti-codons with the mRNA codons starting with methionine, which is always #1. As soon as tRNA-amino-acid #2 has lined up, it should link arms with #1, and so forth.
6. Once the peptide chain has been completed, have it turn around and face the class, while the mRNA players return to their seats. Now have the tRNAs read (in sequence, starting with #1) the name of the amino acid each of them has incorporated into the peptide chain.
7. Now have the tRNA-amino acid students turn over their flash cards, in sequence from left to right, and read the words on the back. The message should be “This is how DNA codes for a protein.”

TEMPLATES

Templates for the Gene Expression flash cards follow on pages T41-T68.

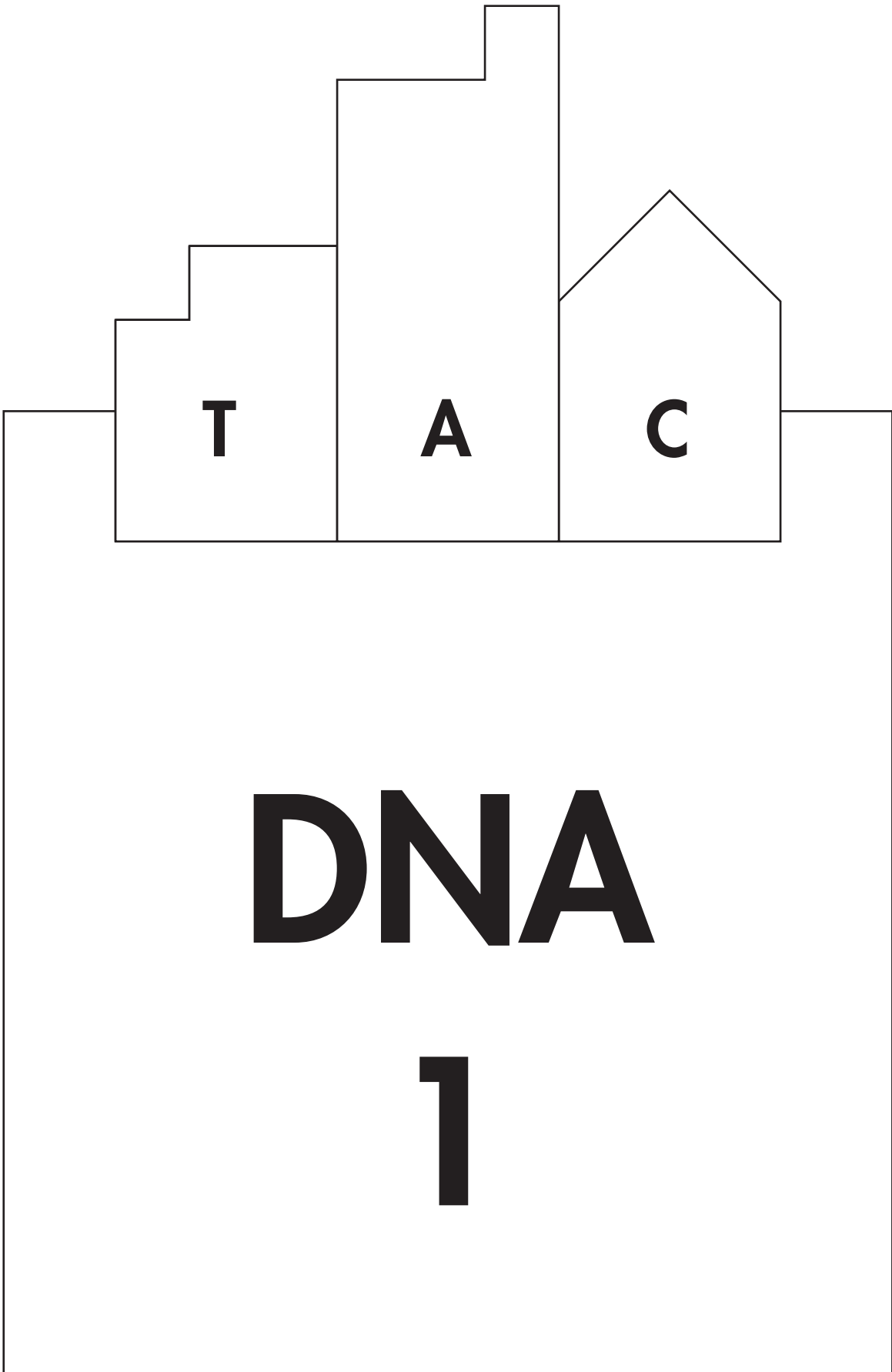

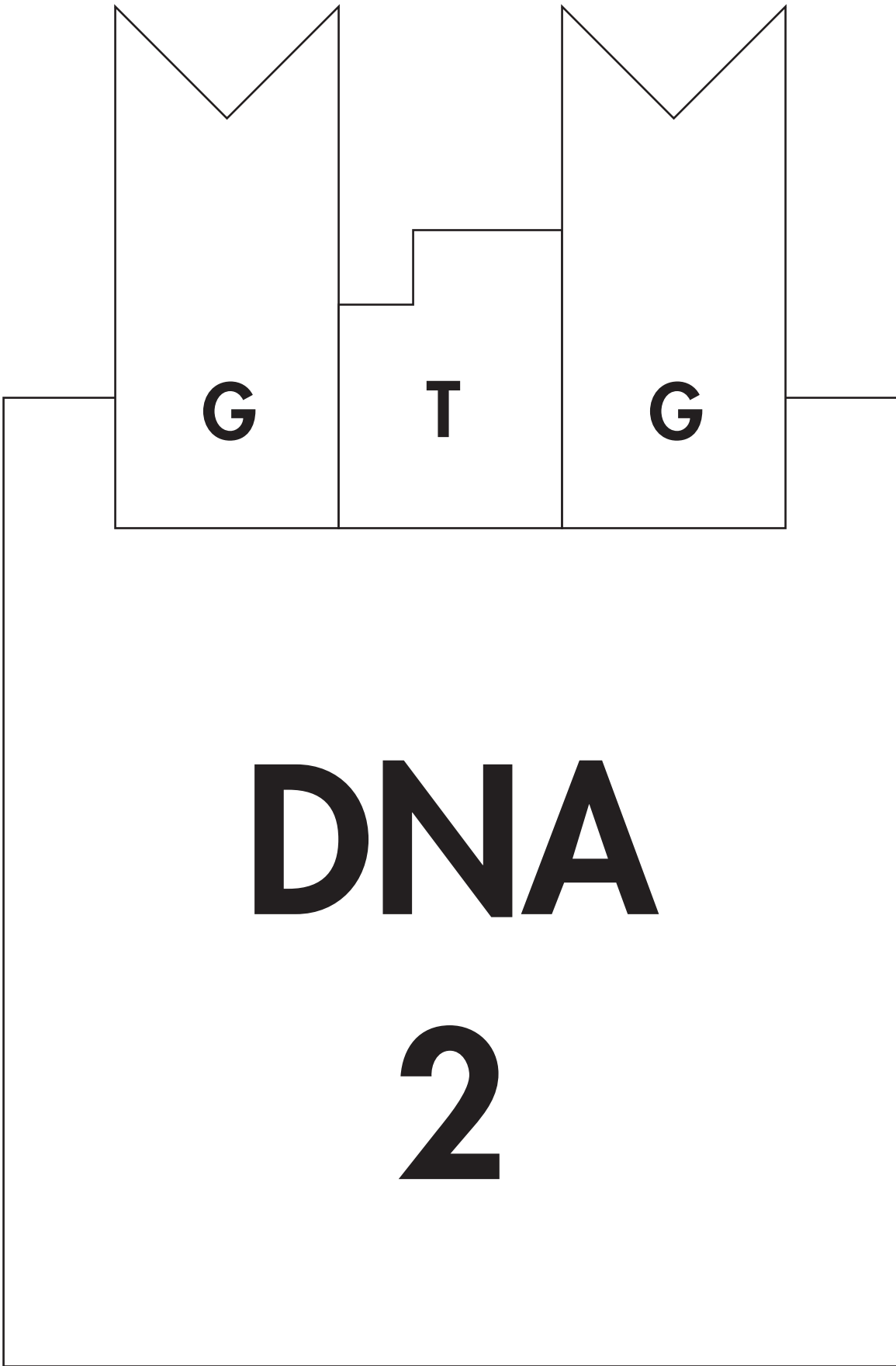

DNA

2

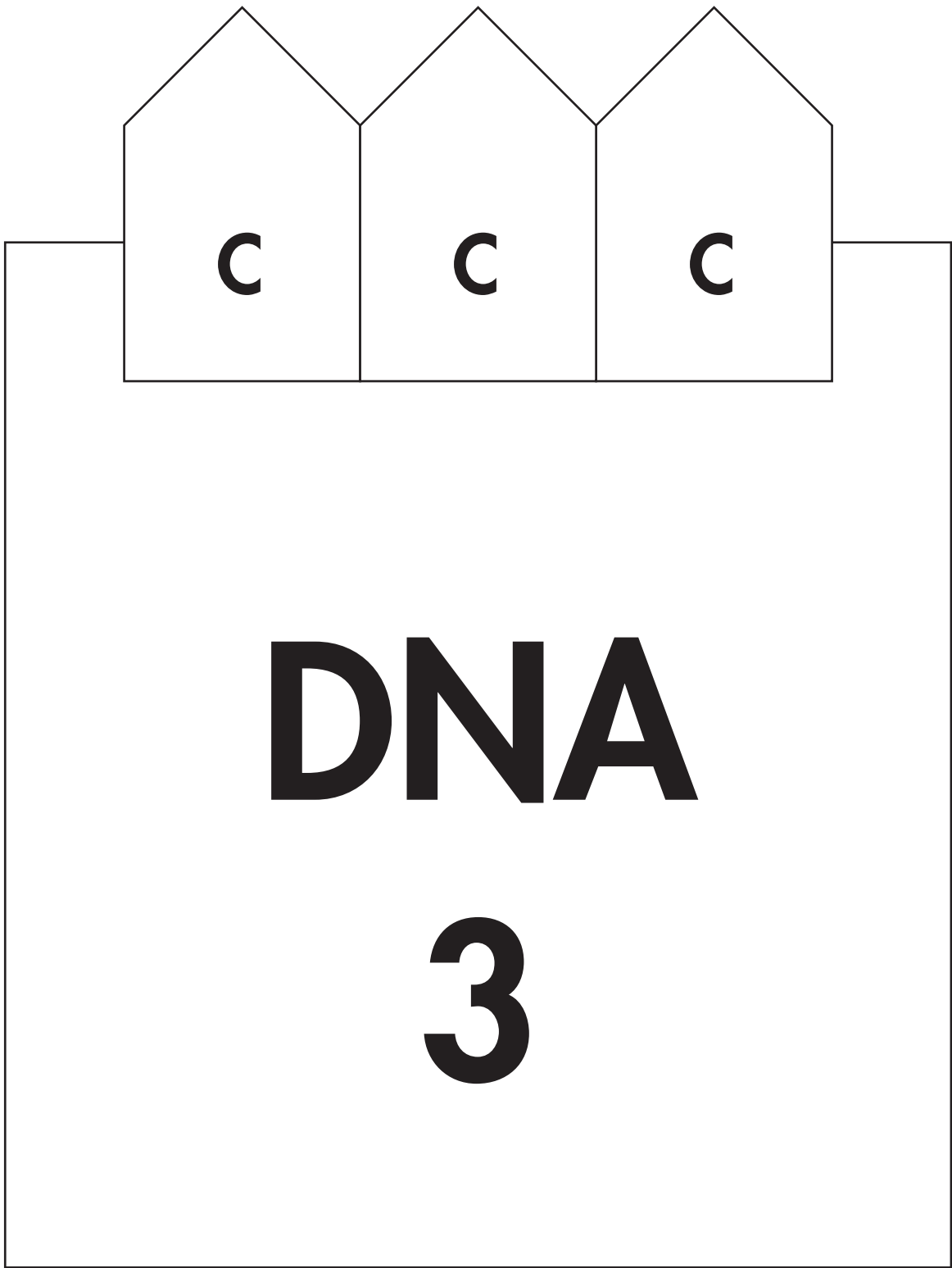

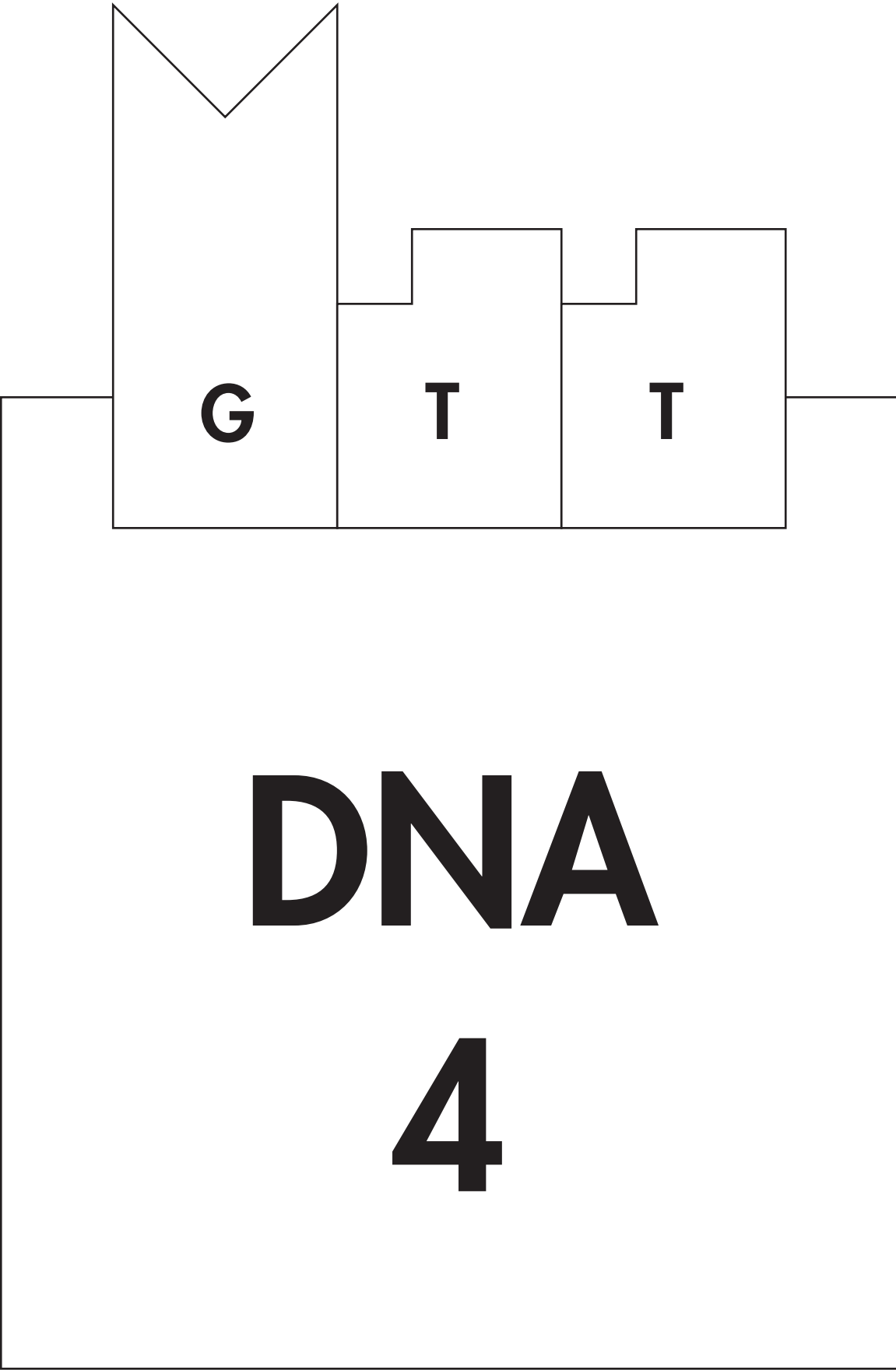

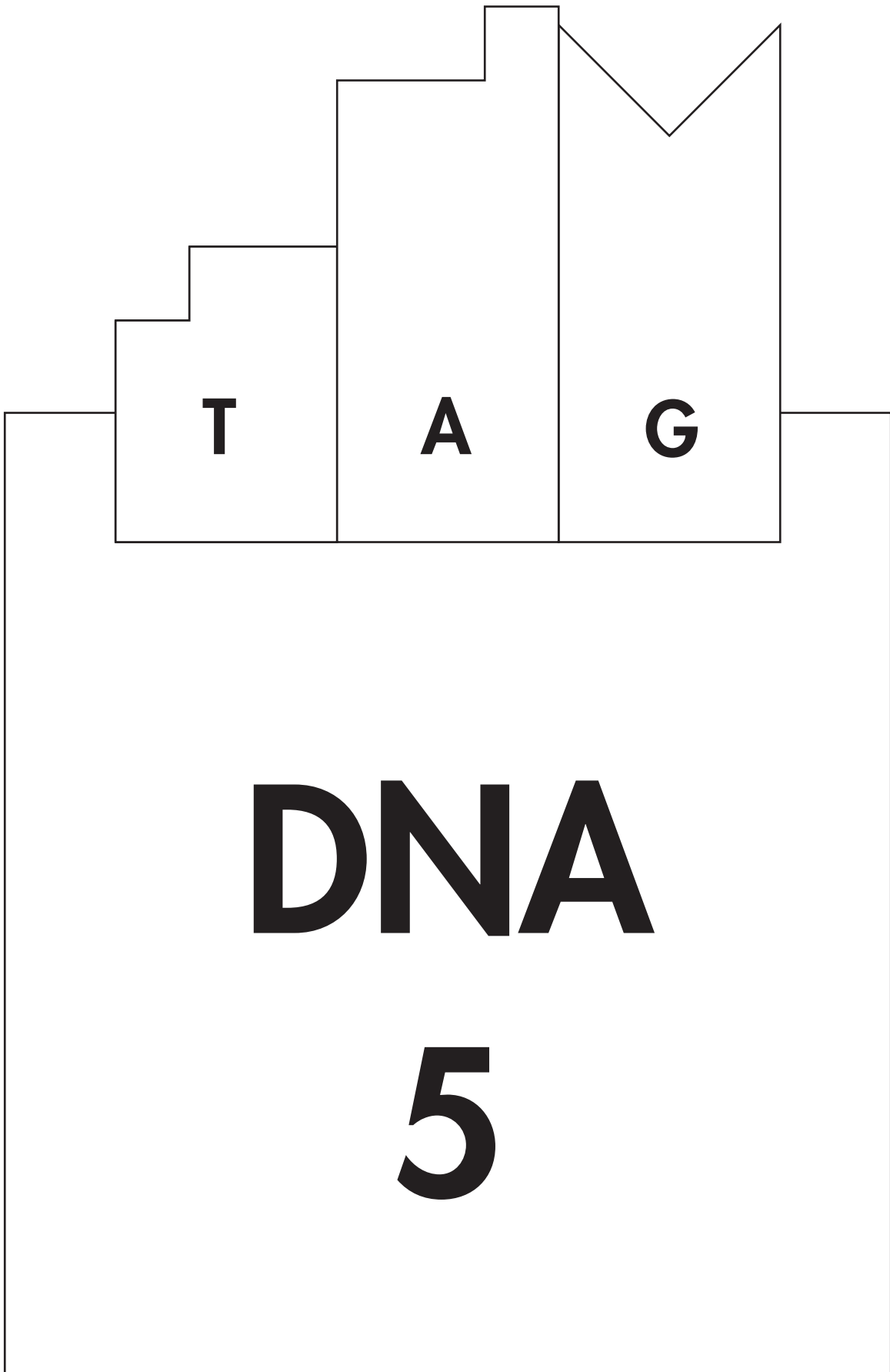

T

A

G

DNA

5

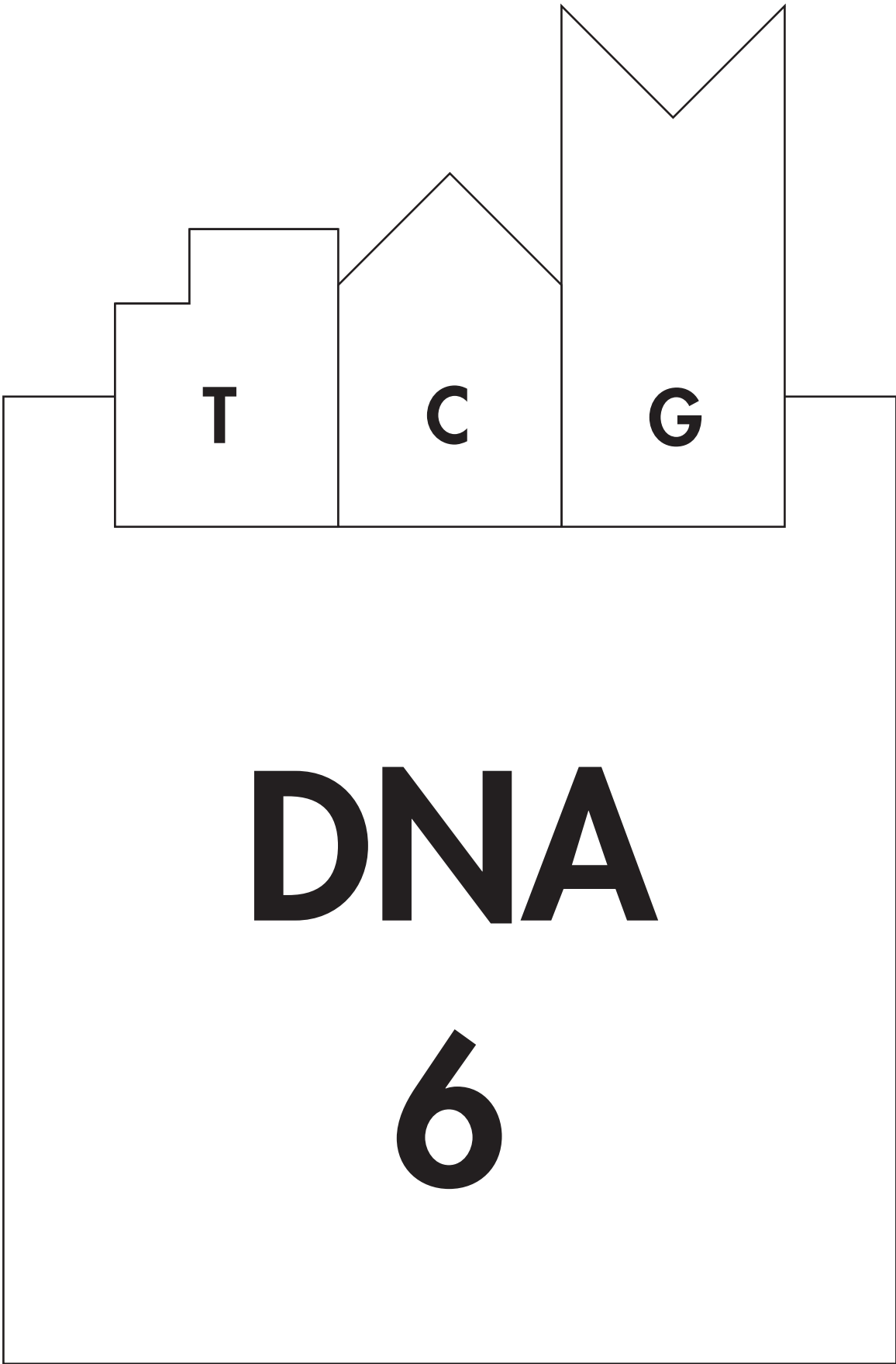

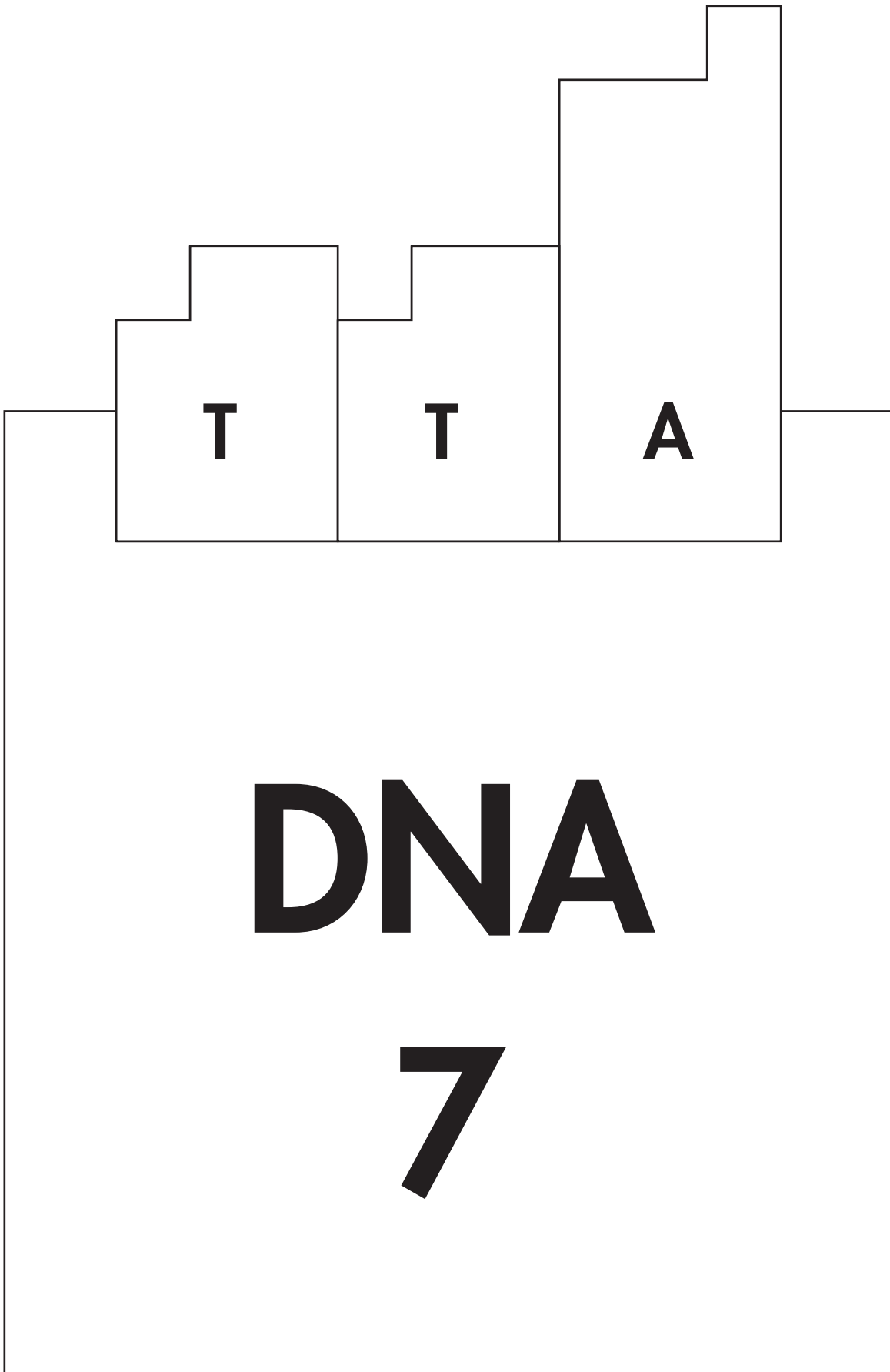

mRNA

1

A

U

G

mRNA

C

A

C

mRNA

G

G

G

mRNA

C

A

A

mRNA

A

U

C

mRNA

A

G

C

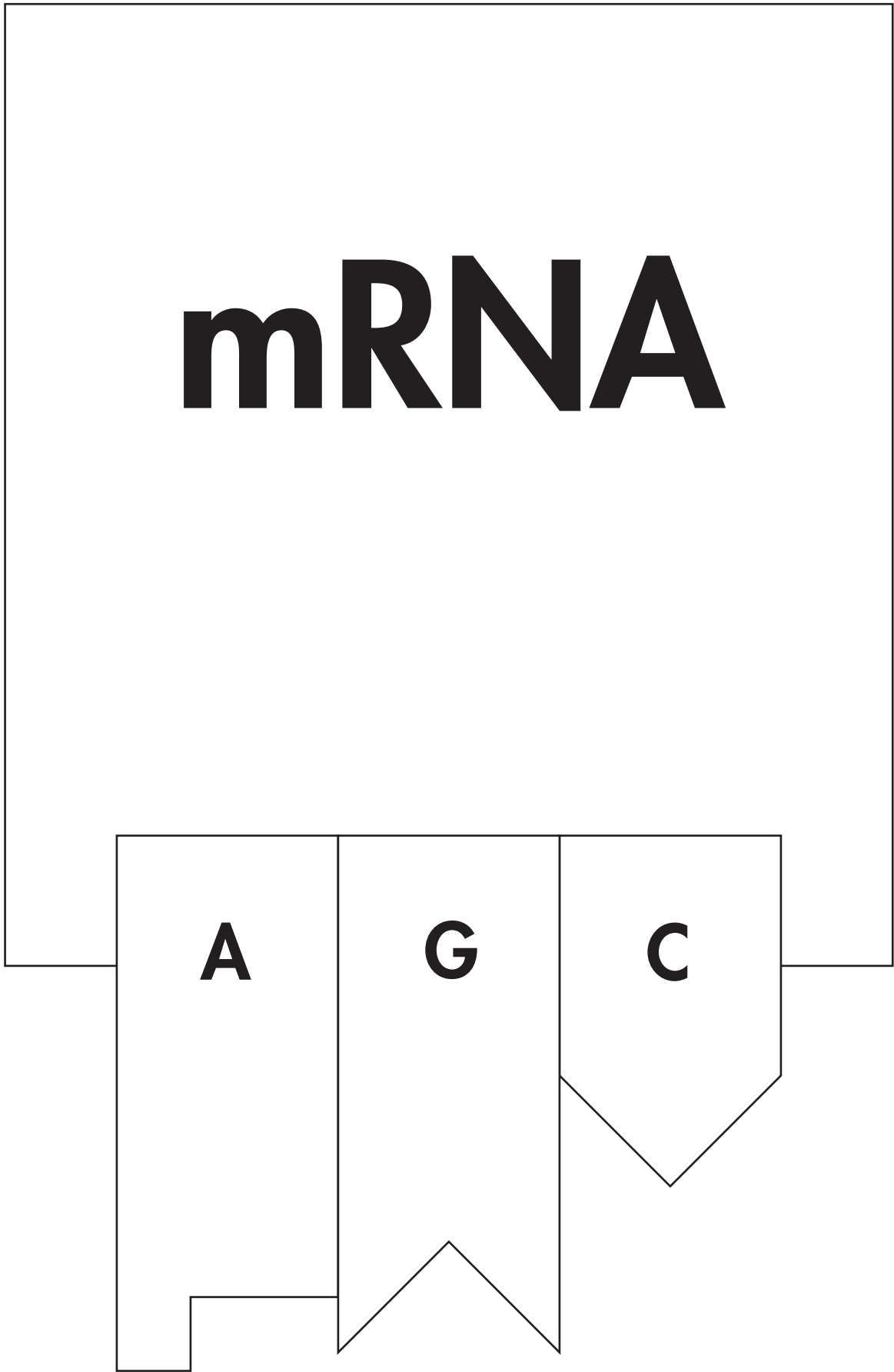

mRNA

A

A

U

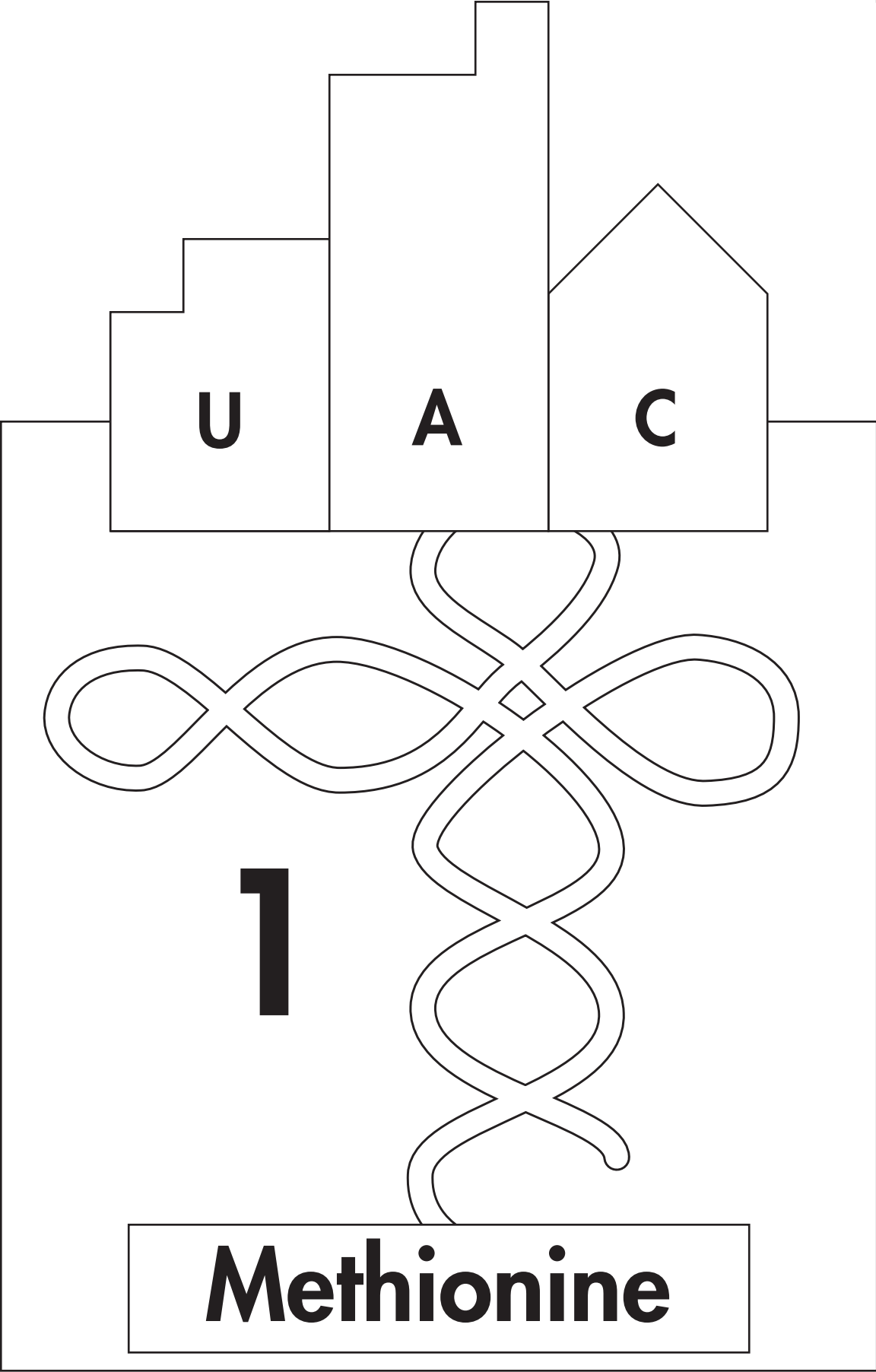

Methionine

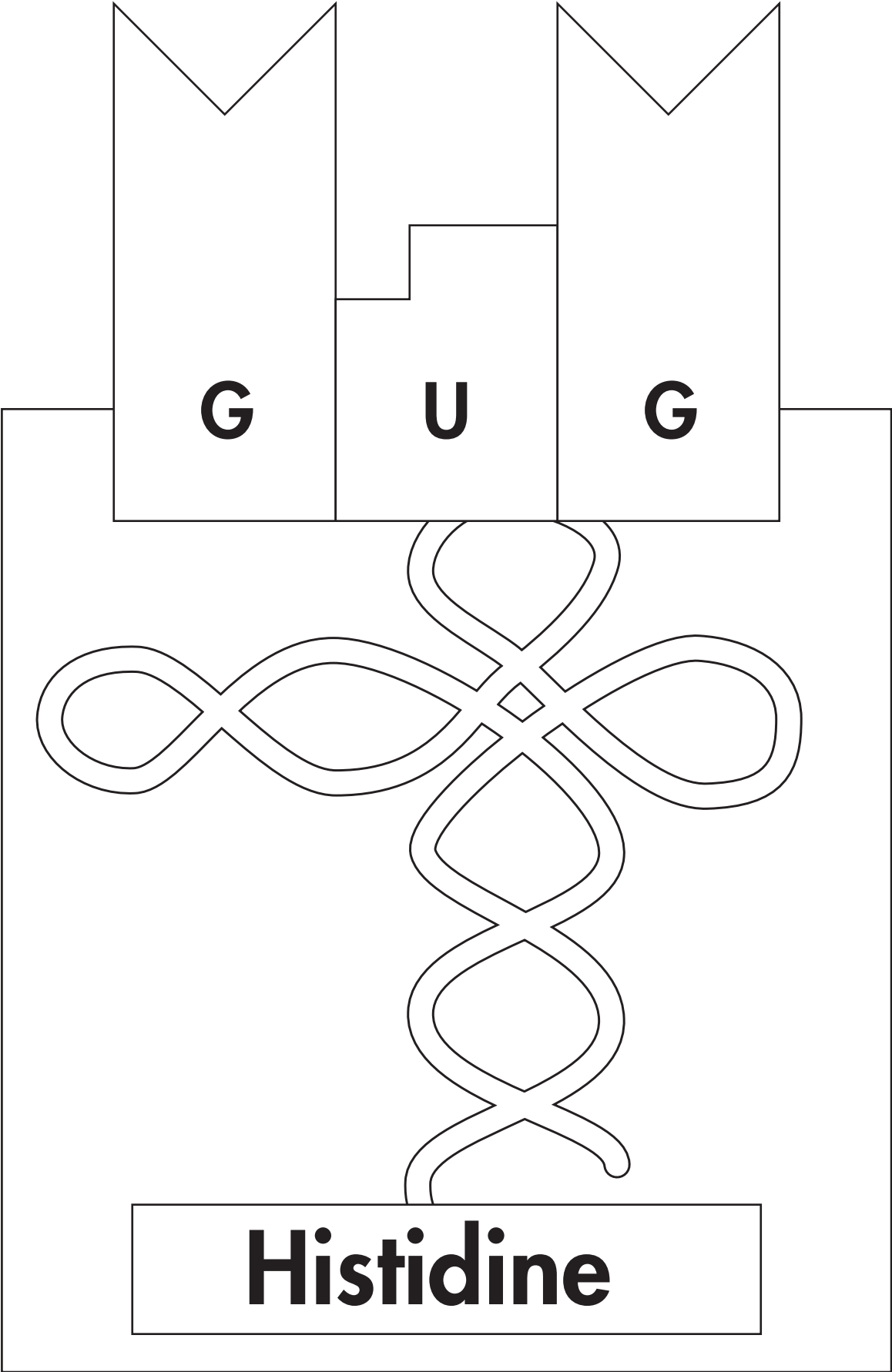

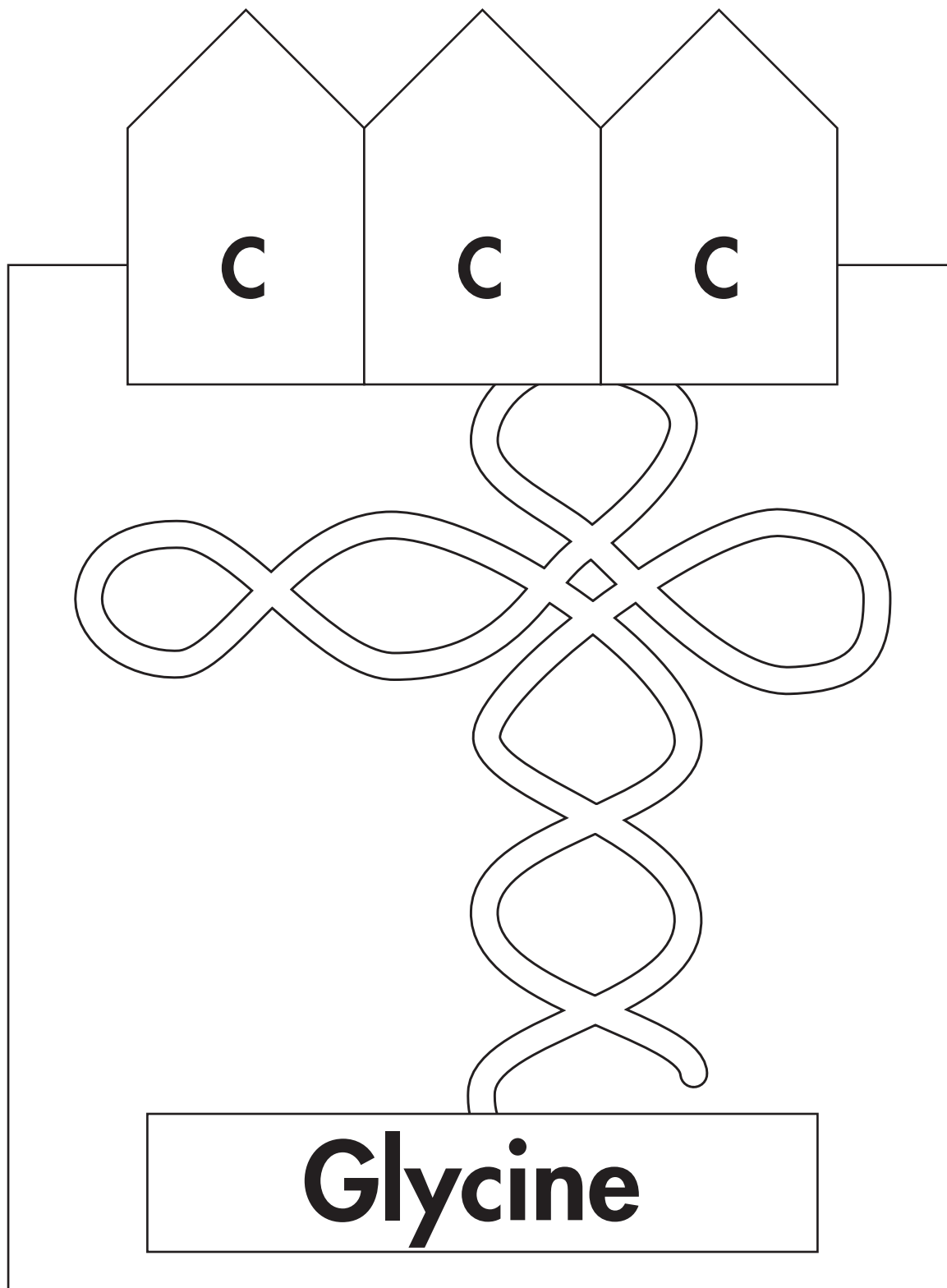

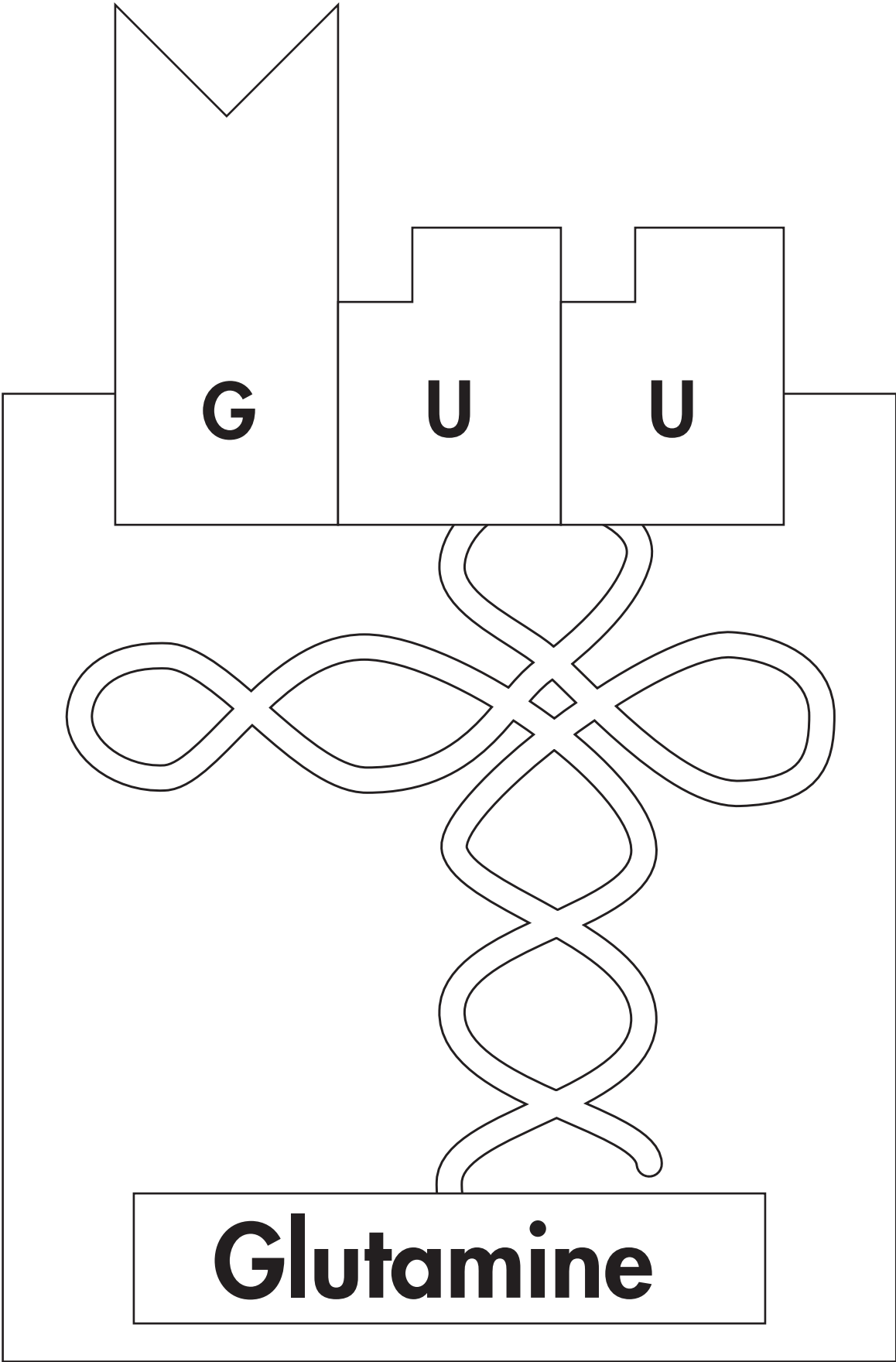

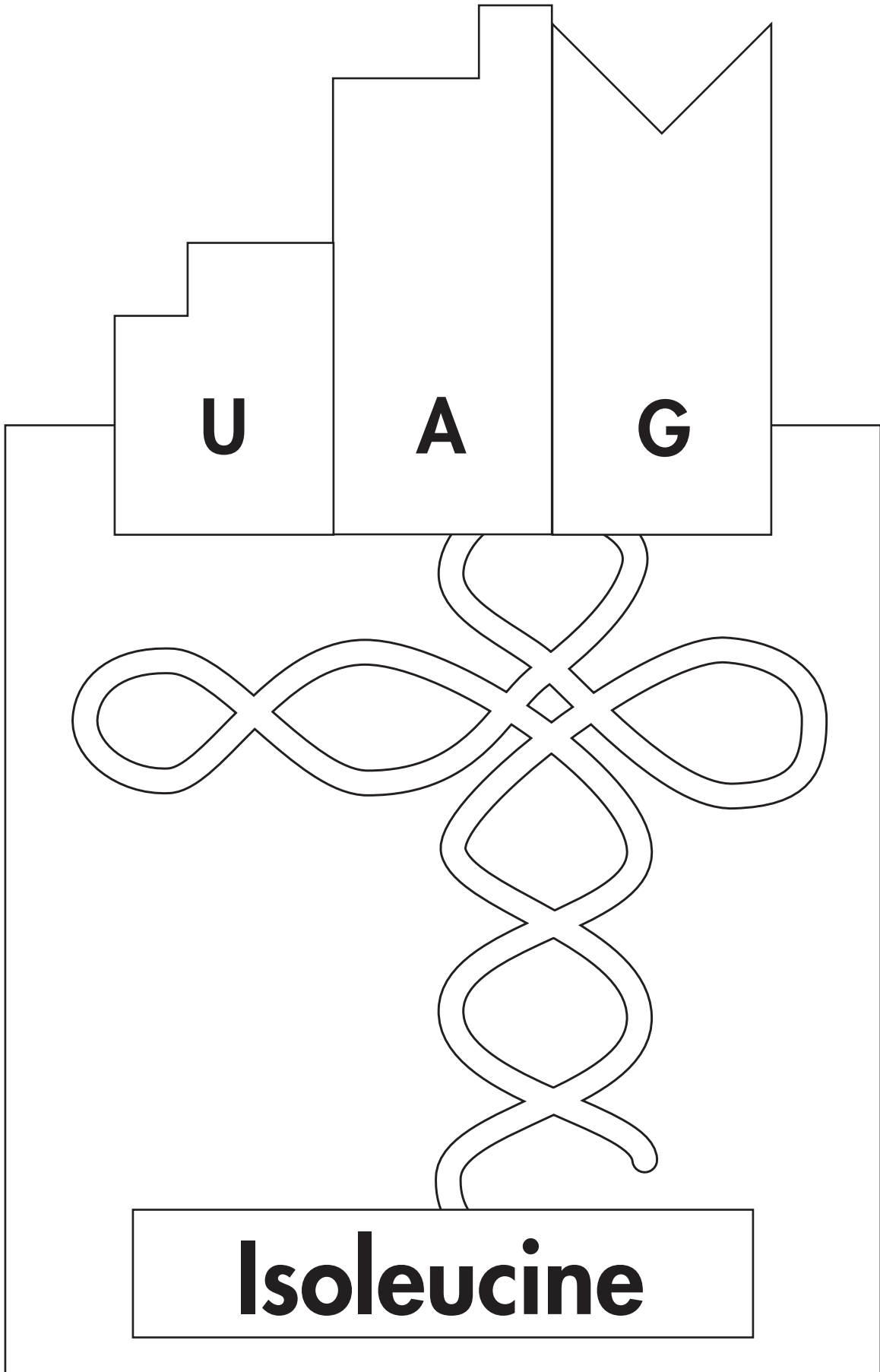

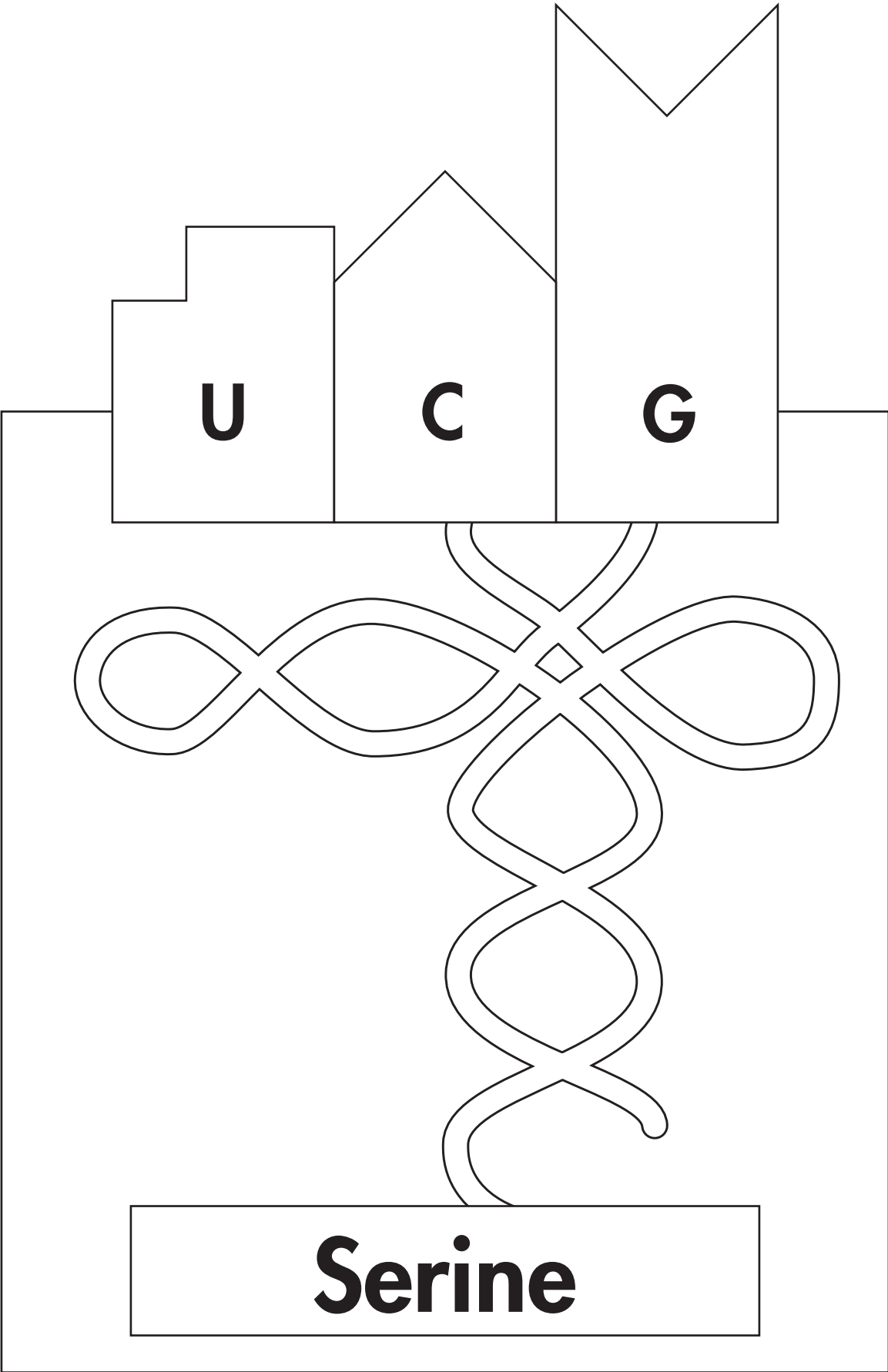

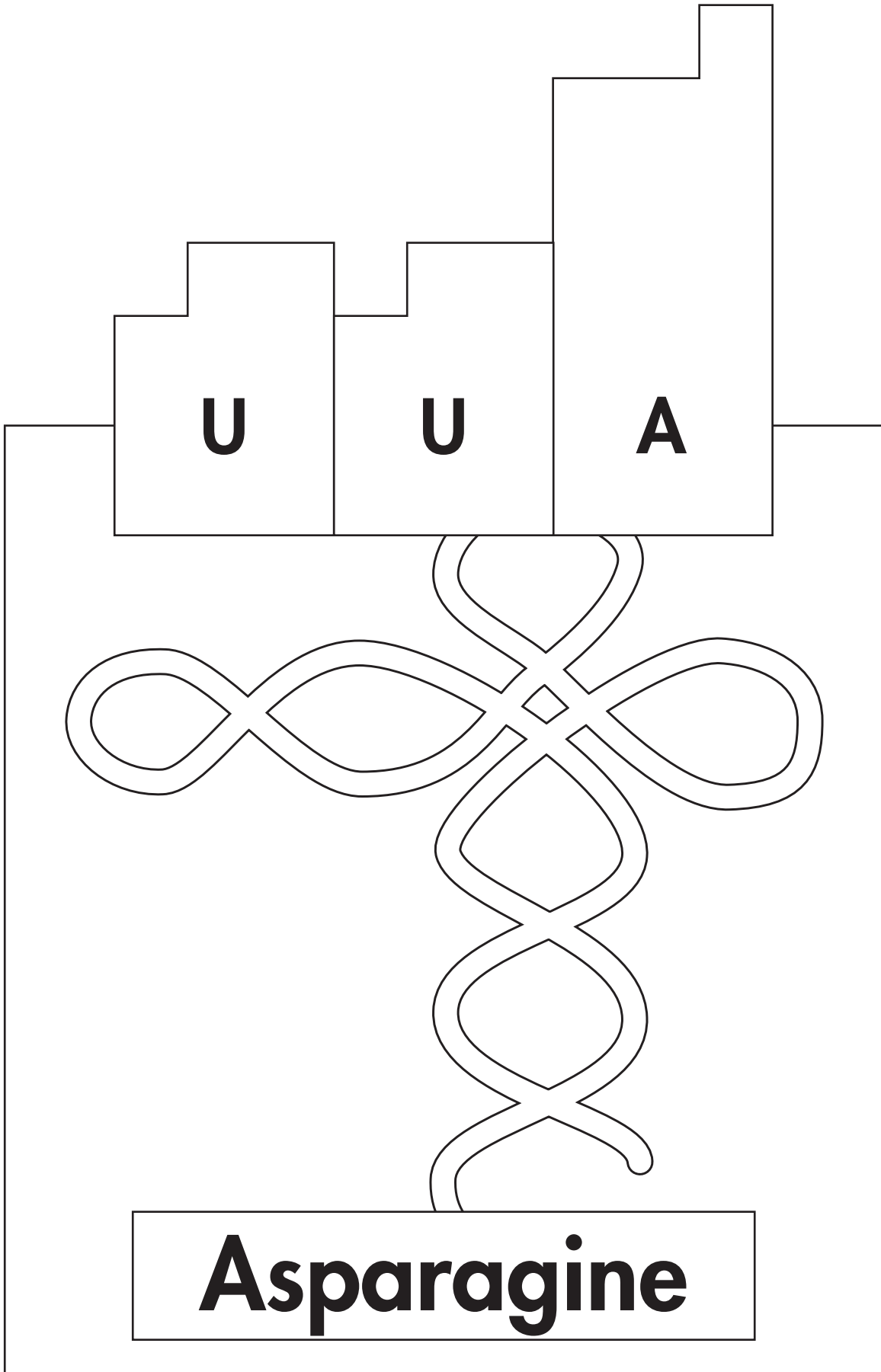

protein!

for a

codes

DNA

how

iS

This

Paper Proteins: Models for Simulating Gene Expression

STUDENT PAGES 49-50

LESSON OVERVIEW

“Paper Proteins” differs from the Gene Expression Dance in that it provides students (or pairs of students) an opportunity to practice their base pairing individually and to visualize more clearly the role that such base pairing plays in both transcription and translation.

TIME LINE

This activity requires 15 -20 minutes.

MATERIALS

For each student or pair of students:

- 1 set of paper protein puzzle pieces

ADVANCE PREPARATION

The templates for the “Paper Proteins” exercise will need to be photocopied in much the same way as the ones for “The Gene Expression Dance” were. However, there are two important differences: a fourth color will be needed for the amino acids (which were on the same cards as the tRNAs last time) and a complete set of these pieces will be needed for each student (or pair of students, if you prefer).

Each of the template pages contains enough pieces of one type for three sets. Thus, if you have 30 students working in pairs and will need 15 sets of “Paper Protein” pieces, you will need to make five copies of each page. Of course, lamination will greatly extend the useful life of these pieces.

ANSWERS TO QUESTIONS IN “PAPER PROTEINS”

What is the process in which an mRNA molecule that is complementary to a DNA molecule is produced? *transcription, or RNA synthesis*

What is the process in which a protein that has an amino acid sequence specified by an mRNA molecule is produced? *translation or protein synthesis*

TEMPLATES

Templates for Paper Proteins follow on pages T70-T73.

DNA

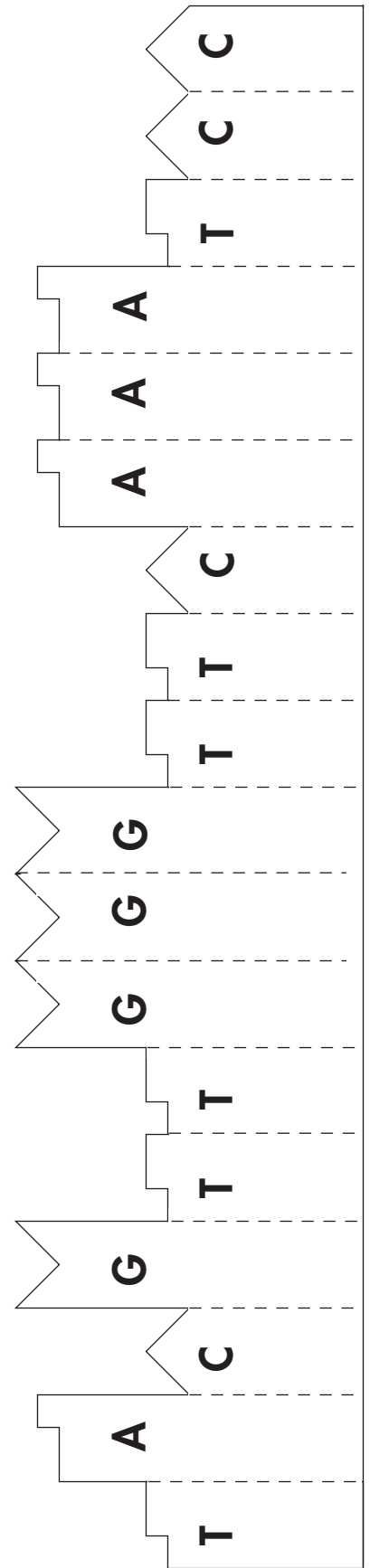
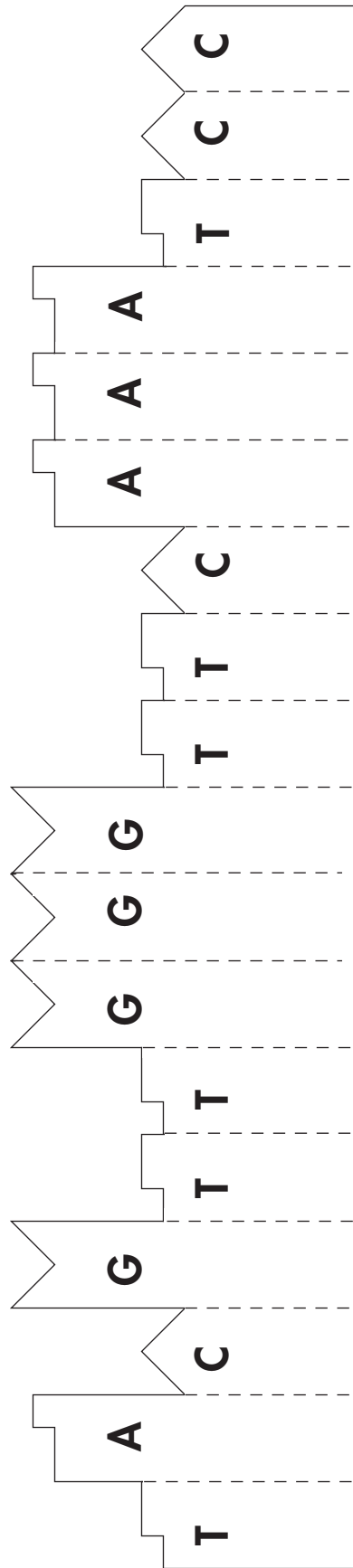
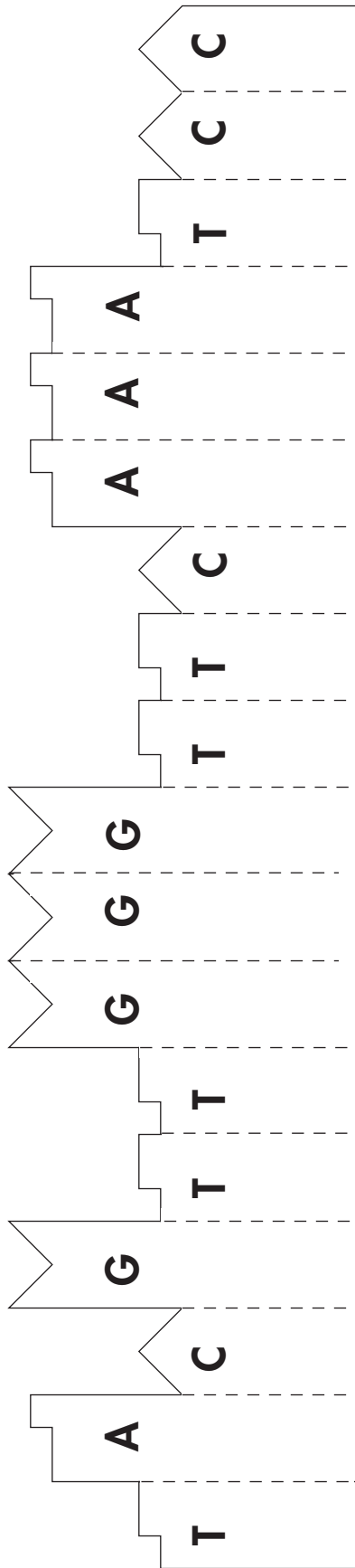

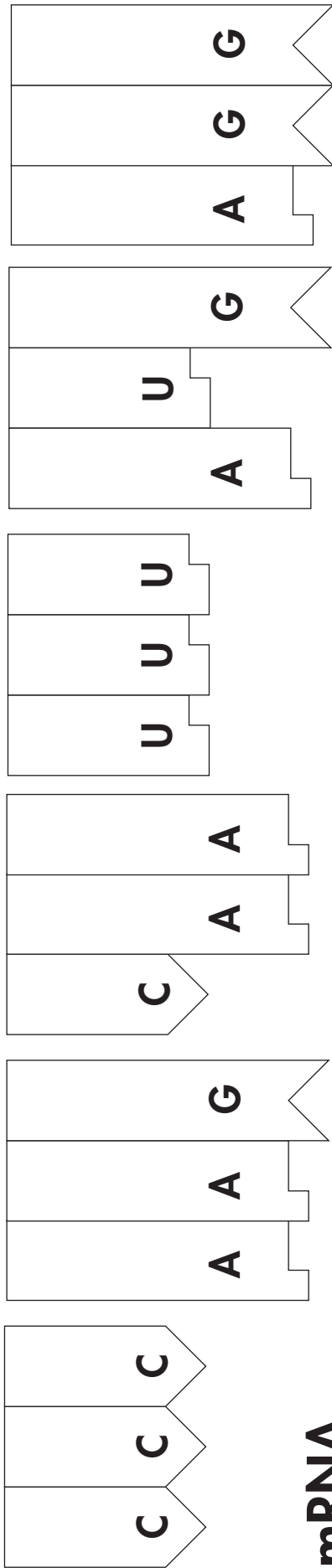

mRNA

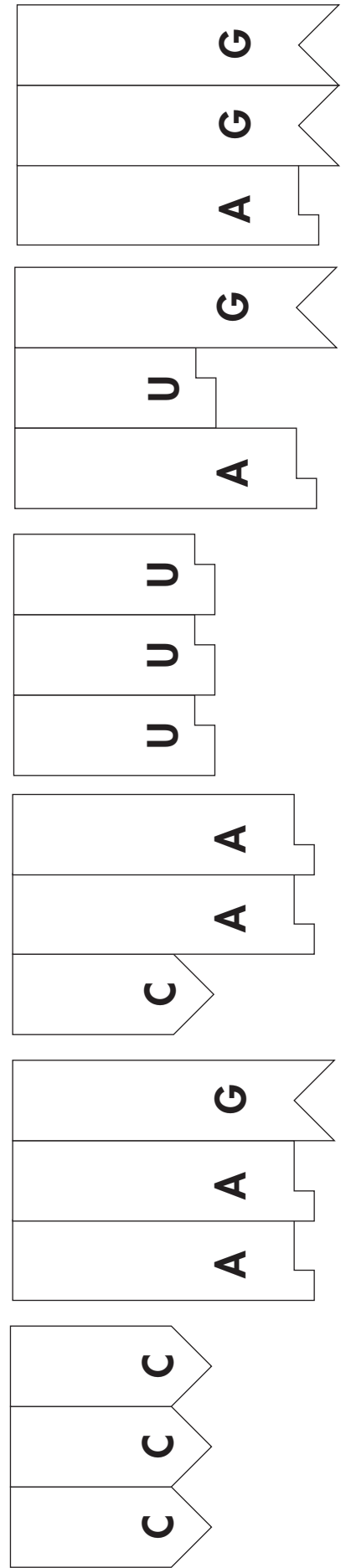
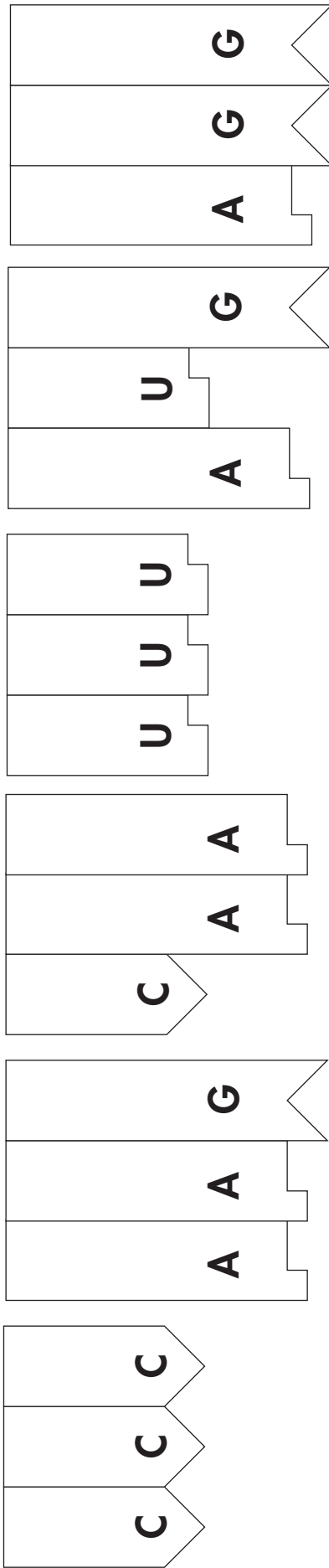

Amino Acids

Lysine

Proline

Phenyl-
alanine

Arginine

Methionine

Glutamine

Lysine

Proline

Phenyl-
alanine

Arginine

Methionine

Glutamine

Lysine

Proline

Phenyl-
alanine

Arginine

Methionine

Glutamine

Using the Genetic Code to Translate an mRNA

STUDENT PAGES 51-52

LESSON OVERVIEW

IT IS WIDELY BELIEVED that the breaking of the Enigma Code (the secret code used by the German armed forces) was the single most important event leading to the eventual victory of the Allied Forces in World War II. Whether or not that is true, the breaking of the **genetic code** in the 1960s surely rates as one of the most important events in the history of genetics – indeed in the history of science!

Before outlining how that important feat was accomplished, it is worth taking a few moments to discuss an extremely common error in the way the term ‘genetic code’ is used in the popular press. One reads such statements as "scientists announced today that they have discovered the genetic code for the protein that causes Huntington’s disease," or "the Human Genome Project is an international effort to determine the complete genetic code for making a human being." Statements like these make it sound as though each feature of each organism has its own private genetic code. This is not the case. It is no more true that there is one genetic code for hemoglobin and a different genetic code for insulin than it is true that there is one Morse code for a message such as "stop at once" and a different Morse code for the Gettysburg Address. Telegraphers everywhere used the same Morse code for every message they ever sent, regardless of its content. Similarly, worms, whales, watercress and humans all use the very same genetic code for every message they send from any of their genes to their ribosomes.

The Morse code is a list indicating which combinations of dots and dashes stand for which letters of the English alphabet. Likewise, the genetic code is a list indicating which mRNA nucleotide triplets (or codons) stand for which amino acids (as shown in the table on S52).

Just as the breaking of the Enigma Code during World War II required large numbers of people working for several years with complicated equipment, so the breaking of the genetic code was a long and complex process, involving very complicated synthetic chemistry on the part of several creative biochemists and their associates. By 1960 it had already been clearly established (by a clever genetic method that is too complicated to go into here) that the genetic code was written in mRNA in the form of non-overlapping nucleotide triplets, without any separators or ‘punctuation marks.’ The first codon was deduced in 1961 when a biologist named Marshall Nirenberg (who later shared the Nobel Prize for the major role he played in breaking the code) made a synthetic mRNA consisting only of a string of uridines (U’s). When he used this ‘poly-U’ mRNA in a protein-synthesis reaction, he found that a protein consisting only of a string of phenylalanines (polyphenylalanine) was made. Thus he deduced that UUU was a codon standing for phenylalanine. By similar methods, he and his colleagues quickly established that CCC stands for proline, AAA stands for lysine, and GGG stands for glycine. Then the hard work

began. It was soon established, for example, that a synthetic mRNA with a long string of alternating U's and C's was used by a protein synthetic system to make a protein in which serines and leucines alternated. So either UCU or CUC must stand for lysine, and the other triplet must stand for serine. But which was which? Working out the rest of the code involved a lot of very hard and complicated chemistry. But astonishingly, the job was completed (by Nirenberg's lab and two others) in only four more years, and by 1965 the genetic code – the table given on S52 – became available for all to use, to decode the 'meaning' of all genes, from bacterial to human ones.

In the previous two exercises, the concept of the genetic code was bypassed for simplicity, by giving students game pieces that were shaped so that they only fit together one way. Thus, the amino acid sequences came out right in each case, without the need for any higher-level decision-making on the part of your students. In this exercise, however, in order to perform a correct conceptual translation of an mRNA nucleotide sequence, the students will be required to use the genetic code to 'decipher' the message.

TIMELINE

This activity requires about 20 minutes. Because it will be the first time the students will have encountered the genetic code, it may be useful for you to lead them through the first couple of steps of translation, to show them how to look up a codon in the table, and find the amino acid for which it stands.

ANSWERS TO “USING THE GENETIC CODE TO TRANSLATE AN MRNA”

DNA Coding Strand	mRNA	Amino Acid
T	A	
A	U	Methionine
C	G	
C	G	
A	U	Valine
G	C	
G	C	
T	A	Histidine
A	U	
A	U	Leucine
C	G	
T	A	
G	C	Threonine
T	A	
G	C	
G	C	Proline
G	C	
C	G	
T	A	Glutamic acid
T	A	
C	G	
T	A	Glutamic acid
C	G	
T	A	
T	A	Lysine
T	A	
A	U	
G	C	Serine
T	A	
C	G	
G	C	Alanine
C	G	
C	G	
A	U	Valine
T	A	

Note: You may wish to inform your class that sickle cell anemia is a result of a mutation (heritable change) in the DNA coding for β -globin that changes the seventh codon from GAA to GUA. What change in the amino acid sequence of β -globin does that mutation cause?

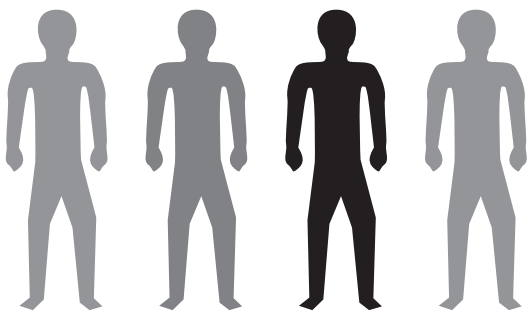
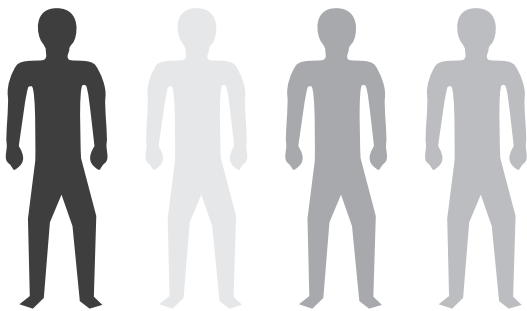
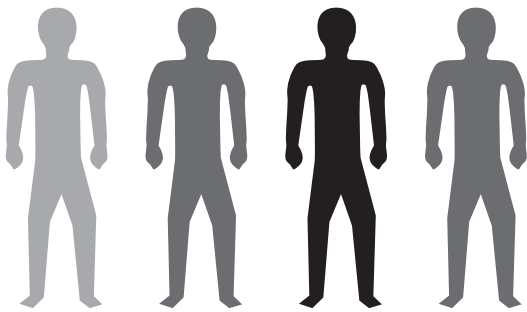
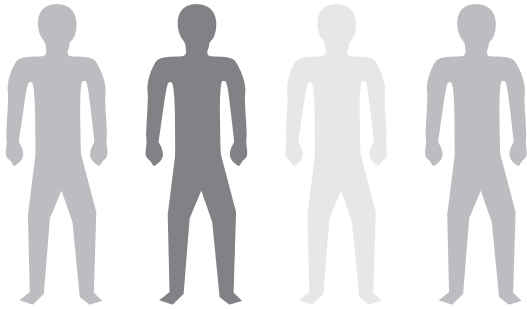
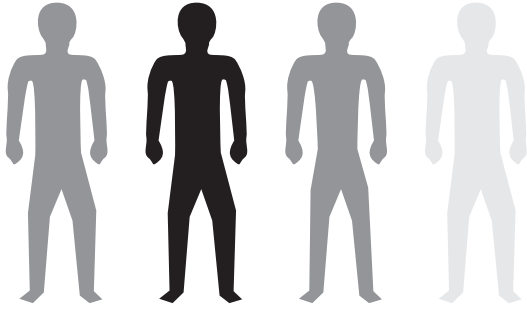

CHAPTER 1

**DNA: The
Hereditary
Molecule**

SECTION E

**How Does
DNA
Determine
a Trait?**

Chapter 1: Section E Background

THIS SECTION DEALS WITH an aspect of genetics that most people find more difficult to follow than the relationship between particular genes and the proteins that they encode. We refer to the rest of the chain of connections that links genes to visible phenotypic traits. If you and your students have much more difficulty understanding the protein-to-trait part of this relationship than you have understanding the gene-to-protein part of the relationship, you are not alone! Even geneticists often have great difficulty understanding the basis for a known protein-to-trait relationship. The reason is that there seldom is a simple and direct path leading from the presence of a particular form of a protein to a recognizable trait with which that protein is known to be connected. There are usually many layers of biological complexity interposed. An example may be helpful in understanding this concept.

Cystic fibrosis is a heritable disease affecting about 1 in every 2,500 Caucasian children. Children with cystic fibrosis are doomed to die in early childhood (almost always of respiratory failure), unless they receive intensive medical care. When the cystic fibrosis gene was finally cloned and sequenced in 1991, it was found that the wild-type version of that gene encodes a membrane protein that controls the passage of chloride ions across the plasma membrane of cells. The mutated version present in cystic fibrosis patients causes a modest defect of chloride transport in cells throughout the body. How in the world does a modest defect in a chloride transport in cells throughout the body cause children to die of respiratory failure? The connection is far from simple or direct, as the flow chart on the next page clearly illustrates.

The following are the critical steps: (a) the defect in chloride transport leads indirectly to accumulation of thick mucus in the lungs; (b) the mucus serves as a growth medium and hiding place for a bacterium called *Pseudomonas aeruginosa*; (c) the body mounts an intensive immune response toward the bacterium but cannot get rid of it, because of thickness of the mucus within which the bacteria are living; (d) thus the immune reaction becomes chronic, resulting in chronic inflammation that damages the lung. In reality, it is the child's own immune response, not the defective cystic fibrosis gene or protein — or even the bacterial infection — that causes fatal damage to the lung. Nevertheless, it is clear that it is the genetically defective cystic fibrosis protein that sets the whole chain of events in motion, and that is, therefore, the ultimate cause of the respiratory failure.

The example just given is not exceptional. In a great many cases the detailed pathway leading from a particular version of a gene to a particular phenotypic trait is at least as indirect and difficult to discern as the pathway in the case of cystic fibrosis. Indeed, it is cases near the other end of the spectrum — such as the exciting one that your students will get to experience in this section of the course, in which there is a very clear and obvious gene-to-trait connection — that are the exception. In the exercise being referred to, your students will use a piece of DNA to introduce a new visible trait into a population of bacteria. Exceptional or not, this exciting exercise should help the students appreciate the fact that the gene-to-visible trait connection is real.

PROTEIN-TO-TRAIT RELATIONSHIP

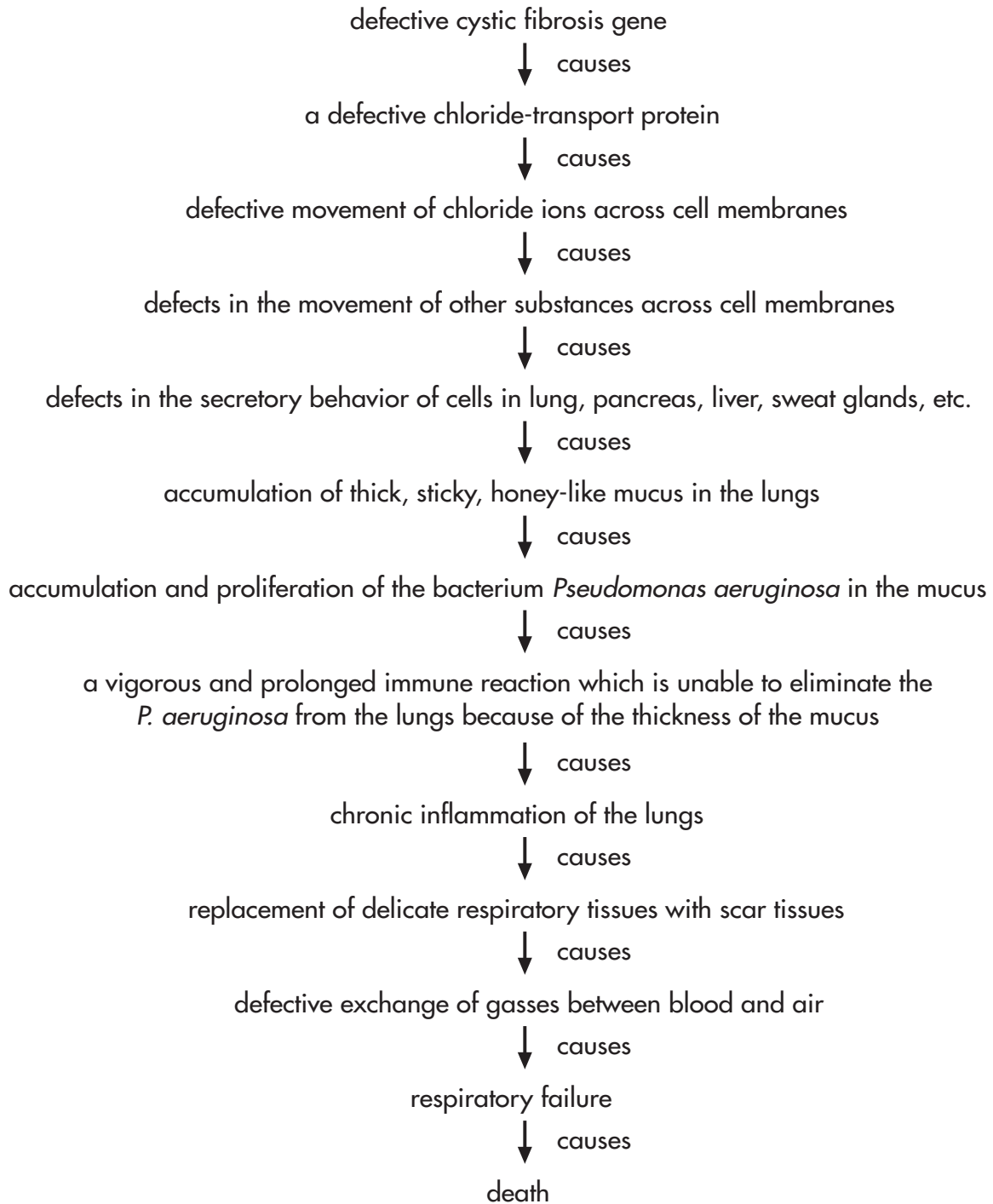

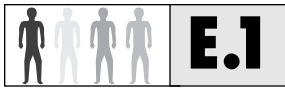

An Introduction to the Connection Between Genes and Visible Traits

STUDENT PAGE 54

LESSON OVERVIEW

This lesson is a brief student reading assignment designed to familiarize your students with the (often indirect and frequently complex) ways in which proteins encoded by DNA determine our visible traits. Depending on how sophisticated you think your class is, you might want to reinforce this lesson by discussing the indirect connection between the cystic fibrosis gene and the cystic fibrosis disease symptoms that are discussed in your background information for Section E. You could use a transparency based on page T79 for this purpose.

TIMELINE

It will probably take an average student about 15 minutes to read this material. It could be assigned as homework.

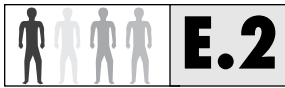

Shine On!

LESSON OVERVIEW

You and your students are about to become genetic engineers!

In this exercise the students will have the opportunity to change the phenotype of a bacterial population dramatically — make them glow in the dark — by providing them with a new piece of DNA. This should be an exciting experience for both them and you. This exercise should reinforce the concept that DNA is the carrier of hereditary instructions more forcefully than spoken words, or words on paper, ever could.

The technique that your students will use to make their bacteria glow in the dark is called **transformation** (or sometimes **DNA transformation**). Transformation is the process by which an organism gains a new heritable trait when it incorporates a bit of DNA coming from another organism that possesses that trait.

It would be difficult to exaggerate the extent to which the entire field of biology has been changed during the past 60 years as a result of the discovery and application of the process of transformation. Therefore, it is worthwhile to take time to consider just a few of the important contributions transformation has made to both basic and applied aspects of biology and medicine before going into the details of the procedure that will be followed in this exercise.

First of all, transformation played a critically important role in biologists' understanding of the physical basis of heredity. As you and your students have read (S21), the first solid evidence that DNA was the carrier of hereditary information came in 1944 when Oswald Avery and his coworkers demonstrated that heritable traits could be transferred from one strain of bacteria to another via DNA. In this case, the trait being transferred was pathogenicity: the ability to cause pneumonia in mice. It had been discovered many years earlier that some mysterious “transforming factor” could be extracted from pathogenic bacteria and used to change nonpathogenic bacteria of the same species into pathogenic ones. But it was not until the careful studies performed by Avery that the world had any clue that the “transforming factor” was actually DNA. Although not everyone believed Avery's results immediately, enough people did that the study of DNA increased dramatically and resulted in the “molecular-genetic revolution” of the last 60 years, about which we will have more to say shortly.

One of the next chapters in the history of transformation research was not so bright and cheery, however. At very nearly the same time that Avery and his co-workers were announcing the news that their bacterial transforming factor was DNA, the practice of medicine was being transformed by the first widespread use of penicillin to treat a variety of infectious diseases. Soon penicillin was joined by streptomycin and several other antibiotics, and the golden age of ‘wonder drugs’ had begun. Many people believed that

all infectious diseases would soon become things of the past. But as physicians began prescribing antibiotics with greater and greater frequency, disturbing reports began to appear indicating that various disease-causing bacteria that had been fully susceptible to certain antibiotics a few years earlier were suddenly becoming resistant to them. Research revealed that this was merely a new version of the chemical warfare that various types of microbes apparently had been engaging in for eons, without humans ever having been aware of it: One fungus or bacterium, x , would evolve a gene product (an antibiotic) that was toxic to some other microbe, y , with which x was competing for space and resources. This would give microbe x a survival advantage for a time, until microbe y evolved a gene (an antibiotic-resistance gene) encoding an enzyme that inactivated the toxic substance being produced by x . Then a mutation in organism x would change the chemical nature of the antibiotic being produced, so that it could no longer be inactivated by organism y . And so on....

From a human perspective, the insidious thing about the antibiotic-resistance genes that have developed is that (1) they almost always are not carried on the main chromosome of a bacterial cell but are carried on small circular molecules of DNA that are called **plasmids**, and (2) as a result such genes are readily passed from one kind of bacterium to another (see diagram below) so that a pathogenic bacterium can inherit an antibiotic-resistance plasmid from a completely unrelated kind of bacterium. Moreover, because many plasmids carry genes conferring resistance to several different antibiotics, the pathogen may become resistant to several unrelated antibiotics simultaneously. It is this kind of DNA transformation process, involving plasmids, that accounts for the fact that after humans thought they had conquered the dread scourge of tuberculosis, the causative agent (*Mycobacterium tuberculosis*) has come roaring back in a highly lethal form that is resistant to nearly every known antibiotic! Some microbiologists now fear that the human race may be in for a tuberculosis epidemic that will make the AIDS epidemic pale by comparison.

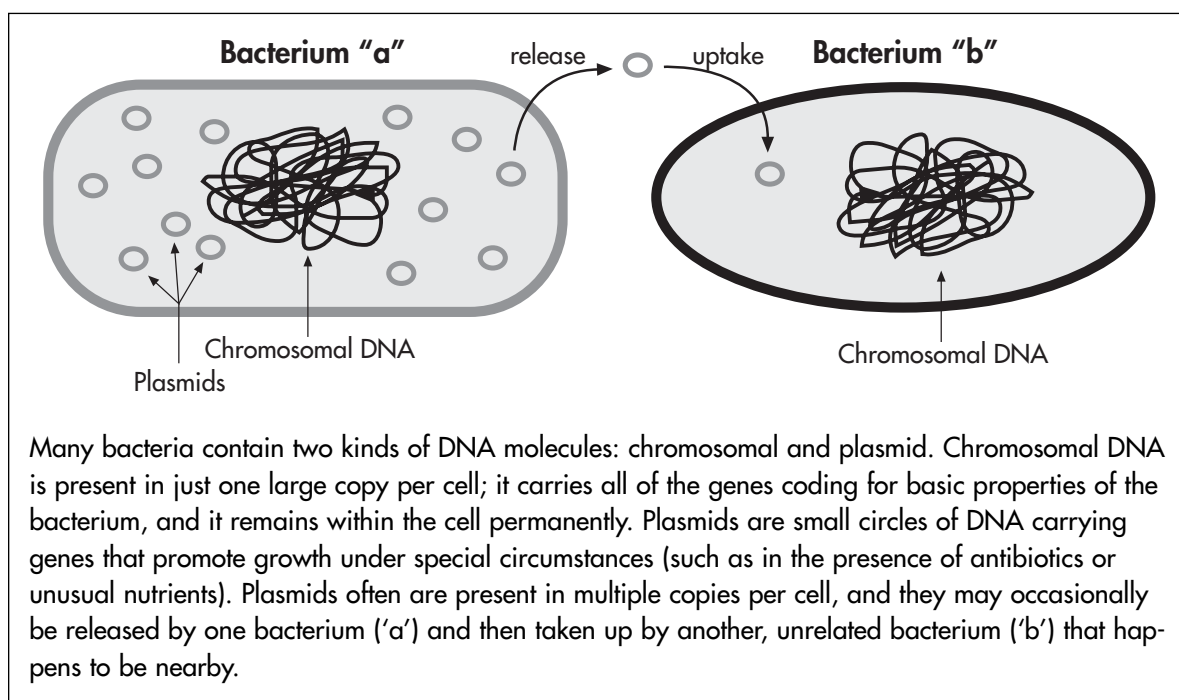

In any case, there is a different, and much less grim, aspect of plasmid-mediated transformation to be considered. Recombinant DNA research, the cloning of genes, and genetic engineering all began as adaptations of plasmid-mediated transformation. Indeed, plasmids have played a central role in nearly every aspect of the genetic revolution that is now in progress.

The first breakthrough on the pathway to genetic engineering came in the early 1970's, when it was discovered that plasmids that had been modified by insertion of a foreign gene could still be used to transform bacteria. Once it was taken up by a bacterium, such a modified plasmid was replicated repeatedly, as the bacteria grew and divided. As a result, a clone of bacteria containing billions of copies of the foreign gene could be generated overnight. In the first trial or two, the job of inserting a gene of interest into such a plasmid was extremely difficult and took weeks of careful, painstaking work that only the most experienced biochemists could manage. But a second major breakthrough came at nearly the same time, when **restriction enzymes** – enzymes that reproducibly cut DNA molecules at particular nucleotide sequences – were discovered. Restriction enzymes made it possible to cut both a plasmid and a chromosome containing a gene of interest in predictable places and in a form such that they could be readily joined together to make a **recombinant DNA molecule**. It was not long before restriction enzymes had changed recombinant DNA research and gene cloning from a complicated procedure that could be completed in only one or two highly sophisticated laboratories to a standard procedure that could be executed on most any lab bench. The number of genes from plants, animals, and humans that have been cloned in bacterial plasmids is now astronomical, and it is highly likely that in the future the lives of your students will be affected by the genetic revolution in ways we can scarcely imagine.

In this exercise, your students will attempt to use plasmid-mediated DNA transformation to make *E. coli* cells glow in the dark. The plasmid that will be used is one that carries seven genes encoding the seven proteins that make the bacterium *Vibrio fischeri* glow in the dark naturally.

The chances that your students will be able to execute this exercise successfully will be increased, however, if they first take time to practice certain techniques that they will have to use in order to succeed as genetic engineers. Therefore, there are three parts to this exercise. First, the students will practice setting and using the micropipettor to measure and dispense tiny volumes of reagents. Then they will practice the microbiological techniques that will be required to grow their transformed bacteria without inadvertently contaminating their culture plates with other bacteria or fungi. Finally, in the third part, they will transform *E. coli* with the plasmid carrying the luminescence genes of *V. fischeri* and culture the resulting transformants.

Shine On!

A. How to Read a Micropipettor STUDENT PAGES 55-57

LESSON OVERVIEW

Modern biology lab exercises typically employ volumes of reagents in the microliter (μl , or 1/1,000 of a milliliter) range, which are far smaller volumes than most people are used to thinking about. (For example, a 1/4 tsp. measuring spoon, which is the smallest measuring device found in most households, will hold more than 2300 μl of fluid.) A precision device called an adjustable micropipettor is invaluable for measuring such volumes quickly and accurately. The micropipettor your students will use in this exercise will be a 1000 μl model, which has a maximum capacity of 1000 μl , or 1 ml. Other adjustable micropipettor models are available with maximum capacities ranges from 1 μl to 5000 μl . All such micropipettors are delicate instruments, so students should be cautioned to use them with care (as they should be with any delicate instrument).

As a rule of thumb, an adjustable micropipettor can be relied on to deliver volumes between 10% and 100% of its rated capacity with a reasonable degree of precision. But this means that if you wanted to measure a volume of 50 μl , for example, you would be ill advised to try to do so with a 1000 μl micropipettor; for such volumes you should use a smaller micropipettor, such as a 200 μl model.

It is strongly recommended that you practice the following two exercises before the first class, until you are able to set, read, and use the micropipettor proficiently.

TIMELINE

It is recommended that you devote a full 50 minute period to discussion of the laboratory procedures, micropipetting practice, and practicing microbiological techniques. The micropipetting practice requires approximately 10-15 minutes.

MATERIALS

For each group of four students:

four pairs of safety goggles	a marking pen
one 1000 μl micropipettor	a tube of colored water
a set of sterile pipette tips	3-4 pieces of white filter paper
a waste container	

ADVANCE PREPARATION

Students enjoy seeing the colored circles on the filter papers that result from their micropipetting practice. You may want to provide tubes of more than one color. It works best to have one micropipettor for each student group.

Micropipettors can be ordered from:
Midwest Scientific
800-227-9997
www.midsci.com
Alpha Pette micropipettors- catalog # A1000

We recommend using sterile, individually wrapped micropipette tips.

Micropipettor tips can be ordered from:
Fisher Scientific
800-766-7000
Micropipettor tips- catalog # 21-372-2

PROCEDURE

- 1. How to read a micropipettor.** You will note that as you turn the adjusting wheel of the micropipettor, the numbers visible in the windows change. As you will see from the upper diagrams on S55, on a 1000 μl micropipettor the numbers in these three windows (reading from top to bottom) indicate the volume in 1000's, 100's and 10's of μl 's, respectively. Note also that a zero is visible in the upper window at all times, except when the micropipettor is set at its maximum volume of 1000 μl . (You should warn students that they should not try to set the micropipettor above its rated capacity, or they could damage it seriously.) When the students have set the micropipettor properly for the four trial volumes that are specified, the micropipettor should read as follows:

Note that the marks at the bottom of the bottom window represent 2 μl intervals, so for a volume of 556 μl , the pointer should be set on the third mark to the left of the five, as shown in the diagram.

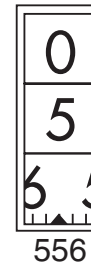
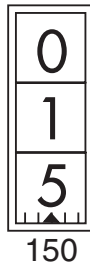

- 2. Micropipetting Practice.** The students should be given the following instructions before they start:
 - The micropipettor should never be dipped into fluid without a plastic pipette tip on the end of it.
 - When students are working with bacteria, it will be important to keep the part of the pipette tip that dips into the liquid sterile; so they must practice putting the tip on the micropipettor without allowing it to touch their fingers or any other non-sterile object.
 - They should practice depressing the plunger to get a feeling for the amount of force required to reach each of the two stops.
 - The plunger should be depressed to the first stop before inserting the tip into the liquid that is to be picked up.

- Once the tip has been inserted into the liquid, the plunger should be released slowly and steadily.
- After the micropipettor has been removed from the liquid, the plastic tip should be inspected to see whether there are any air bubbles visible in the liquid. If there are, this indicates that the plunger was released too quickly, air was sucked in, and therefore the volume of liquid taken up was less than was intended. In this case, the liquid should be returned to the tube from which it came, and the filling process should be repeated, this time more carefully.
- When the micropipettor has been properly filled, the tip should be placed lightly against the surface of the tube or paper where the fluid is to be expelled, the plunger should be depressed slowly to the first stop, and then, with the tip still touching the surface, the plunger should be depressed to the second stop in order to expel the last bit of fluid.
- If the micropipettor being used has a tip ejector, the ejector button should be depressed after the used tip is positioned above the waste container. If there is no tip ejector on the micropipettor, the tip should be removed by hand, touching it only at its wide, upper end; then the tip should be dropped into the waste container.

B. Practicing Microbiological Techniques

STUDENT PAGES 58-59

LESSON OVERVIEW

This exercise is a warm-up for the genetic-engineering experiment that comes next. Like just about any other microbiological experiment, bacterial-transformation experiments of the sort we have planned can be ruined if the cultures become contaminated with bacteria or fungi other than the ones that one intended to have present.

The major potential sources of contaminating microbes in such an experiment are equipment and supplies that have not been properly sterilized in advance, and spores or active microbes that are inadvertently introduced into the experimental materials while the experiment is in progress. The primary sources of such unwelcome intruders are room air, the work surfaces, and the breath, hands, and hair of the experimenters. Providing materials that have been properly sterilized in advance is your responsibility. But keeping these materials free of unwanted visitors during the experiment will depend on the ability of your students to use what are called sterile microbiological techniques.

Therefore, it is important to give your students time to practice using such techniques, before challenging them to perform the transformation experiment that will be coming next.

Note: You may wish to avert student concerns by assuring them that the strain of *E. coli* that they will be working with is completely different than the one that causes food poisoning. It is a laboratory strain that has been in use for decades, without ever causing any health problems.

TIMELINE

This exercise will require approximately 10 minutes of class time and an incubation time of 2-3 days.

MATERIALS

For each group of 4 students:

- | | |
|---------------------------------|-------------------------------------------------|
| 4 pairs of safety goggles | 1 spray bottle of disinfectant |
| 1 1000 μ l micropipettor | 1 petri dish containing <i>E. coli</i> colonies |
| 1 sterile pipette tip | 1 piece of plastic wrap |
| 2 sterile inoculating loops | 1 tube of sterile nutrient broth (NB) |
| 1 waste container with bleach | 1 petri dish with sterile nutrient agar |
| 1 small beaker with 70% alcohol | 1 marking pen |

ADVANCE PREPARATION

(Note: The bacteriological supplies used in this exercise could be obtained from many different biological supply companies; so please order from your favorite supplier. The reasons we list catalog numbers for one particular company (Carolina Biological Supply Company; 1-800-334-5551) are (1) to provide specific examples of the kind of materials needed and (2) to simplify the ordering process for teachers who do not have appropriate catalogs.)

1. Nutrient agar plates

You will need a minimum of two sterile nutrient-agar dishes per student lab group. There are several alternatives for providing such dishes, depending on whether time or money is more limiting in your classroom. The easiest (and most expensive) choice is to buy ready-to-use, pre-poured nutrient-agar dishes (e.g., Carolina cat. # BA-82-1862). The next simplest (and a somewhat cheaper option) is to buy sterile, disposable, 100 X 15 mm petri dishes (e.g., Carolina cat. # BA-74-1250) and premixed nutrient agar (e.g., Carolina cat. # BA-77-6360). In this case, you can just melt the bottled nutrient agar in a boiling-water bath, pour your dishes, allow them to cool, and then store them refrigerated until they are needed (plan on using 25 ml of nutrient agar per dish). It is much cheaper (but also more work) to buy dry nutrient agar (e.g., Carolina cat. # BA-78-5300), make up your own nutrient-agar solution, sterilize it, and pour into petri dishes as above. To dissolve and sterilize the dry nutrient agar, you will need either an autoclave or a pressure cooker. Sterilize such an agar suspension for 20 minutes at 15 lbs steam pressure (again, allow 25 mls of nutrient agar per plate).

(Note: Whenever you sterilize liquids in an autoclave or pressure cooker, it is important to have the container with the liquid loosely capped before you heat it, and to avoid venting the sterilizer until it has cooled off enough to return to atmospheric pressure.)

2. Bacterial subcultures

You will need to order a stock culture of *E. coli* on a petri dish (such as Carolina cat. # BA-15-5067; *E. coli*, strain K12). At least one day in advance of the class exercise (and longer if you do not have a 37°C incubator available), you need to use the stock culture to prepare a bacterial subculture on a sterile nutrient-agar dish for each group of students.

For this advance preparation as well as the student exercise that follows, you will need sterile disposable inoculating loops, (e.g., Carolina cat. # BA -70-3039). You will also need a small beaker of 70% alcohol.

(Note: Neither 95% nor 100% alcohol are effective disinfectants, because they dehydrate bacterial and fungal cells without entering and killing them. Always dilute alcohol to 70% to use it as a disinfectant.)

To prepare the subcultures:

- a. Set out your stock *E.coli* culture and your sterile nutrient agar dishes on a flat surface that you have cleaned with a disinfectant (see '6. Spray bottles of disinfectant,' below).
- b. Open the package containing an inoculating loop, being careful not to touch the loop end.
- c. Lift the lid of the stock culture just far enough to allow insertion of the loop. Carefully touch the loop to a single colony of *E. coli*.
- d. Withdraw the loop and close the lid.
- e. Raise the lid of one of your nutrient-agar petri dishes just enough to allow the insertion of the loop. Gently rub the loop back and forth in a zigzag motion over an area of nutrient agar near one edge of the dish.
- f. Withdraw the loop and close the lid.
- g. Resterilize the loop by inserting the tip into 70% alcohol. Remove and allow a few seconds for evaporation.
- h. Turn the nutrient-agar dish a quarter turn, reopen the lid, and insert the newly sterilized loop. Gently rub it in a zigzag motion over the area you previously inoculated and then inward, toward the center of the plate.
- i. Withdraw the loop and close the lid.
- j. Resterilize the loop in the alcohol as before.
- k. Turn the agar dish another quarter turn, reopen the lid, and return the newly sterilized loop to the region you just spread the *E. coli* over. This time very gently stroke across the inoculated area one time, and then draw the loop over the rest of the agar in a zigzag pattern. The goal of this whole process is to spread the bacteria out so thinly that single colonies can grow from individual bacteria.
- l. Repeat steps c-k with additional dishes until you have prepared as many subcultures as you have student groups.
- m. Label the bottom of each subculture dish with *E. coli*, followed by the date. To prevent plates from drying out, and to make them easier to transport safely, wrap stacks of four to five plates in plastic wrap. To prevent condensation from forming on the lids, turn all plates upside down.
- n. Wipe down your work area with disinfectant and wash your hands.
- o. Incubate plates overnight in a 37° C incubator or at room temperature for 2-3 days.

3. Micropipettors and tips

See the previous exercise for recommended sources. Pipette tips need to be sterile for these exercises, so the individually wrapped, presterilized tips mentioned there are best.

4. Nutrient broth

You will need one 1.5 ml microcentrifuge tube (e.g., Carolina cat. # BA-21-5236 or Fisher Scientific cat.# 05-406-16) containing 1 ml of sterile nutrient broth (NB) for each student group (plus a few extra tubes, in case of accidents). NB can be purchased as a sterile pre-mixed solution (e.g., Carolina cat. # BA-77-6380). Dispense one ml per tube with the 1000 μ l micropipettor and a sterile tip. Label all tubes 'NB.'

5. Waste containers with bleach

You will need one waste jar per student group; it will be used for the disposal of items contaminated with bacteria. Add enough tap water to half-fill a quart jar or a 1000 ml beaker; then carefully add 50 ml of household bleach to make a 10% solution. Be sure to caution students about the negative effect of spilled bleach on clothing, eyes, and skin. After a short period in the waste jar, items will be free of living bacteria and can be drained and disposed of in a standard trash container.

6. Spray bottles of disinfectant

These can either be made or purchased. Any good brand of household disinfectant can be purchased from the grocery store. You might purchase a one quart bottle of disinfectant per student group initially and then refill bottles after they become empty with a 20% bleach solution. (Add ~200 ml of household bleach carefully to ~800 ml of tap water in a large flask or beaker [1000 ml capacity or larger].) Refill spray bottles carefully, using a funnel. Be sure to caution your students about the dangers of spraying the disinfectant on clothing, eyes, or skin.

7. At the last minute

To save class time, you will probably want to distribute at least the waste jars, disinfectant bottles, micropipettors and plastic wrap to the student work places before class begins. Then, to avoid congestion around one central spot, it might be a good idea to have a separate supply and return stations for each of the other materials.

At the beginning of this lab, remind students about the dangers of the bleach in the waste jars and disinfectant bottles, about the need to keep things as sterile as possible, and about overall lab safety. A demonstration of sterile technique as well as a discussion of the need to cut down on as many sources of contamination as possible would both be useful. Also, remind the students of the need to sterilize their loop in alcohol between uses.

Have the students examine their cultures on nutrient-agar dishes after they have been incubated overnight at 37°C or for two to three days at room temperature if you do not have a 37°C incubator. Do they have a uniform lawn of bacteria on the dish, or individual colonies derived from single cells, or something in between? Do they have any signs of contamination with foreign bacteria or fungi?

At the end of the lab, have students prepare these dishes (and all dishes contaminated with bacteria) for disposal as follows: unwrap and open the dish, spray bleach-based disinfectant on the agar surface, close and rewrap the dish in plastic wrap. It is then safe to place the dishes in a standard trash can.

PROCEDURE

Some points that you might wish to consider making, as supplements to the printed instructions in the student pages, include the following:

- Petri dishes should be labeled in advance with the name of the group, the date, and the type of culture that is to be placed on them. Labels should be in small letters and placed near the edge of the bottom part of the dish with an indelible marking pen.
- Air in a room that is occupied by many different people every day contains an astonishing abundance of bacterial and fungal cells that will grow rapidly on nutrient-agar plates if they are given any opportunity to do so. Therefore, petri dish lids should be opened only far enough to allow the insertion of the loop or pipette tip being used and should not be kept open any longer than is absolutely necessary to carry out the intended operation.
- The breath of the experimenter is the second most likely source of contaminating microorganisms. Therefore, students should avoid breathing on the dish any more than is absolutely necessary while the lid is raised.
- If any loop or pipette tip has touched any non-sterile surface inadvertently - or even if a student thinks contact might have been made - the loop or pipette tip should not be used. It should be discarded, and a new one should be used.
- Loops or pipette tips should only touch the agar surface very lightly and should never be pressed down hard enough to gouge it.
- Plastic wrap should be used to cover the dishes either individually or in stacks of up to five dishes, and the dishes should be incubated upside down to prevent the development of condensate on the lid, because condensation on the lid greatly increases the probability that the dish will become contaminated.

Shine On!

C. Engineering The Glow-in-the-Dark Bacteria

STUDENT PAGES 60-70

LESSON OVERVIEW

Now that your class is about to do the transformation experiment itself, a few words about certain technical details are in order.

Some species of bacteria take up foreign DNA molecules very readily. Unfortunately, *E. coli* is not such a species -- although it has many other properties that make it highly suitable for laboratory work. Thus, several tricks must be used to get *E. coli* to take up plasmids, and to achieve a reasonably high frequency of transformation. First, one must start with what are called **competent cells**, a strain of *E. coli* that tends to take up foreign DNA more readily than other strains do. The *E. coli* cells provided in the kit from Modern Biology Inc. (see ADVANCE PREPARATION below) meet this criterion. But even competent cells must be treated 'just so' in order to get an efficient uptake of DNA and the desired transformation. First, the cells must be incubated in the cold in the presence of the plasmid DNA as well as a calcium chloride (CaCl_2) solution, which stimulates DNA uptake. Then, after the cells have been soaked in the plasmid suspension long enough that the plasmids have had a chance to diffuse through the cell wall and accumulate near the cell membrane, the cells must be heat shocked (incubated at 42°C) briefly. Heat shock causes small holes to open up in the plasma membrane of the bacteria, so that plasmids can diffuse into the cell. It is this step that is stimulated by the calcium chloride. The heat shock must be timed carefully: if it is too brief, none of the cells will take up plasmids and become transformed; if it is too long, so much cytoplasm will diffuse out through the holes that the cells will die. After being heat shocked for the proper length of time, the cells must next be incubated briefly in the cold again, so that the holes in the membrane will seal back up, preventing any more loss of cytoplasm.

Under the best of circumstances, only a tiny fraction of all *E. coli* cells in a culture will take up a plasmid and become transformed by it. So the next step is to isolate and culture those few cells that have been transformed. For this purpose we will exploit a phenomenon discussed earlier: plasmid-mediated antibiotic resistance. The plasmid that is supplied in the kit (called "plasmid Lux") carries a gene conferring resistance to the antibiotic ampicillin, in addition to the genes required for bioluminescence. Therefore, any cell that has become transformed by the plasmid carrying the bioluminescence genes has simultaneously been transformed to being ampicillin resistant. Thus, if the culture that has been exposed to plasmid Lux is spread out on a dish filled with ampicillin-containing agar, only the transformed cells, called the **transformants**, will grow; the nontransformed cells will be killed by the ampicillin. In this experiment, a control culture (*E. coli* cells that have not been exposed to plasmid) will also be grown on a plain agar dish while the *E. coli* cells that have been exposed to plasmid are being grown on a dish containing ampicillin. By comparing the number of colonies on the two kinds of dishes (see diagram, next page), it will be possible to determine the efficiency of transformation that was achieved in the experiment.

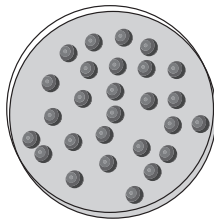

Control culture
Plain agar

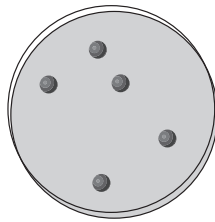

Plasmid-treated culture
Ampicillin-containing agar

TIMELINE

There are two different ways that this experiment can be run. In option A, students go all the way through the exercise in one 50 minute lab period, and have their petri dishes ready to go into the incubator by the end of the class. In option B, they expose their competent cells to plasmid on the first day, but then refrigerate the cells overnight and spread them on dishes the second day. Option B will take about 35 minutes the first day, and 15 minutes the second day. The two options work equally well; choose the one that is more compatible with your class schedule.

MATERIALS

For each group of four students:

- | | |
|-------------------------------------------|------------------------------------------------------------|
| 4 pairs of safety goggles | 7 sterile pipette tips |
| 1 spray bottle of disinfectant | 1 waste container with bleach |
| 1 cup with ice | 1 small piece of Styrofoam with 2-4 holes |
| 1 tube of sterile water (labeled “W”) | 1 tube of nutrient broth (labeled “NB”) |
| 1 marking pen | 1 petri dish with nutrient agar (labeled “WATER”) |
| 1 tube of plasmid DNA (labeled “DNA”) | 1 petri dish with ampicillin/nutrient agar (labeled “DNA”) |
| 1 tube of CaCl ₂ (Labeled “C”) | 1 roll of plastic wrap |
| 1 petri dish with <i>E. coli</i> | |
| 2 sterile inoculating loops | |
| 1 1000 µl micropipettor | |

Per class:

- 1 water bath at 42° C

ADVANCE PREPARATION

1. The kit, “Producing a Strain of *E. coli* that Glows in the Dark” contains material for eight groups of students. The instructions for advance preparation, including information on pouring plain nutrient agar and ampicillin/nutrient agar dishes, are included and should be followed. The pipette tips, inoculating loops, sterile water, CaCl₂ solution, plasmid Lux, control plasmid, frozen *E. coli* culture, and nutrient broth that are needed are all included also.

This kit can be ordered from:

Modern Biology

111 N. 500 West

West Lafayette, IN 47906

(Tel. # 1-800-733-6544)

Producing a Strain of *E.coli* that Glows in the Dark- Catalog # IND-9

2. Sources for materials such as micropipettors and inoculating loops, the preparation of waste containers and disinfectant spray, and general pre-lab preparations are as outlined in the two preceding practice sections. You will need a source of crushed ice for this laboratory as well.

3. Prepare one tube of the following type for each group of students. (Use 1.5 ml microcentrifuge tubes such as Carolina cat. # BA-21-5236 or Fisher Scientific cat.# 05-406-16.)

Tube label	Solution	Volume
W	sterile water	5 μ l
DNA	plasmid Lux	5 μ l
C	CaCl ₂	600 μ l
NB	nutrient broth	800 μ l

4. You will also need to prepare a 42° C water bath. If you do not have a thermostatically regulated water bath, you should be able to prepare one by using a heavy, shallow pot on a hot plate that has good temperature regulation. You might use a steam-table tray borrowed from the school cafeteria, a deep skillet, or some other pan that is much wider than it is high.

Because the temperature of the water bath plays a fairly strong role in determining the probability that this experiment will succeed, you should probably practice regulating the temperature of such a make-shift water bath in advance, and you might want to have some hot water and ice on hand to adjust the temperature at the last minute if necessary.

5. Floating racks for microcentrifuge tubes are commercially available, but they are ridiculously expensive. Perfectly adequate racks for the present purpose can be made by cutting a styrofoam takeout food box into pieces 2-3 inches on a side, and punching two to four holes in each with a sharp pencil. Each student group should have their own styrofoam rack, so that they can get their samples in and out of the 42°C water bath without disturbing any one else's samples. Be sure to warn the students to close the lids on their tubes tightly before dropping them in the water bath, so they won't be in danger of getting water from the bath inside.

HINTS AND TROUBLESHOOTING

- It is important to incubate the dishes for this experiment at 25-30°C rather than the usual 37°C, even though the *E. coli* cells would grow faster at 37°C. This is because the bioluminescence genes carried on the plasmid Lux are derived from the bacterium *Vibrio fischeri*, which is adapted to grow in cool ocean water, and its bioluminescence enzymes would become denatured at 37°C. Thus, even bacteria that have been transformed by plasmid Lux will not glow in the dark at 37°C.
- Be sure that your students observe their dishes in a room that is totally dark, and that they stay in the room long enough for their eyes to become adapted to the dark (3-5 minutes). It may take as long as 72 hours, or even more, for transformed cells to begin to glow in the dark. But the luminescence is ATP (adenosine triphosphate) dependent; thus it is only produced by live, metabolically active cells and may disappear as soon as 2 days after it first appears. Therefore, you may want to consider having the transformation finished on Friday, so that the dishes can be observed daily from the following Monday on.
- Have students disinfect all materials that have been contaminated with bacteria as in the preceding exercise. Be certain that they also wipe down their lab bench with disinfectant and wash their hands at the end of the exercise.

ANSWERS TO PART THREE: SHINE ON! VIEWING PLATES STUDENT PAGE 67

It will require approximately 2-4 days for bacteria to begin to glow in the dark.

After 24 hours the control plate should have a lawn of *E. coli* bacteria covering the entire plate; Colonies (transformants) may not appear on the “DNA” dishes by this time.

After 48 hours, colonies should be present on the experimental dishes, but they may not be glowing in the dark yet.

Sometime between 48 and 96 hours the transformants begin glowing in the dark, and they will usually continue to glow for about 24-48 hours.

LABORATORY WRITE UP ANSWERS STUDENT PAGE 68

1. Purpose: Describe in your own words the reason for performing this experiment.
To see if traits can be changed by adding DNA.
2. Background Information: Give information about the idea of adding genes to bacteria in order to change their traits.
Brief explanation of how bacteria can be transformed.
3. Hypothesis: State the expected outcome of the experiment.
If new DNA carrying the genes for bioluminescence is added to the bacteria, those bacteria will glow in the dark.

4. Independent Variable: State the independent variable.
New DNA
5. Dependent Variable: State the dependent variable.
Glowing in the dark
6. Controls: List the controls.
Bacteria from the same population, but with no DNA added, were incubated on a plain-agar plate; the incubation conditions for both plates were the same.
7. Procedure: Briefly describe in your own words the steps you took to perform the experiment.
See protocol and the overview in teacher pages.
8. Data/Observations: Organize your data and observations into a neat, meaningful chart.
Charts will vary.
9. Conclusions and Recommendations for Future Experiments: Tell what the data mean. Were the results what you expected? Was your hypothesis on target? In addition, write a paragraph telling your ideas for future experiments (how to improve, what other things to try, any mistakes to correct, etc.).
Answers will vary.